



-  *IBM SurePOS 500 Setup*
-  *With ISS45 V7 and V8*
- 
- 
- 

IBM SurePOS 500 Setup with ISS45 V7 and V8

| Date of Issue | Product Identification Number | Part Number | Brief Description |
|----------------------|--------------------------------------|--------------------|--------------------------|
| May 2008 | 45001/113 | 89000442 | Initial Release |
| May 2008 | 45001/113 | 89000450 | Issue 2 |

**© Copyright StoreNext Retail Technologies LLC 1995-2008
All rights reserved**

This publication is protected by federal copyright law. No part of this publication may be reproduced or transmitted into any human or computer language in any form or by any means, stored in a retrieval system, transmitted, redistributed, translated or disclosed to third parties, or de-compiled in any way including, but not limited to, photocopy, photograph, electronic, mechanical, magnetic or manual without the express written permission of StoreNext Retail Technologies LLC or its licensors, if any. This document, notwithstanding the above, may be distributed in electronic or printed form to personnel who are employed by either (1) a StoreNext customer of the subject system of this document or (2) personnel from an authorized StoreNext dealer of the subject system of this document. All copies, so distributed and/or so authorized, shall contain a full copy of this copyright notice.

StoreNext Retail Technologies LLC endeavors to ensure that the information in this document is correct and fairly stated but does not accept liability for any error or omission. StoreNext Retail Technologies LLC makes no representation or warranties with respect to the contents hereof, and specifically disclaims any implied warranties of merchantability or fitness for a particular purpose or non-infringement. No commitments by StoreNext or its suppliers are made from this documentation which is provided for information only.

Development of StoreNext products and documentation is continuous: StoreNext Retail Technologies LLC reserves the right to revise this publication and to make changes from time to time in the contents hereof or in the products herein described or discussed without notice and without any obligation of StoreNext Retail Technologies LLC to notify any person or organization of such revision or changes. Information published in this document will likely become obsolete over time and it is recommended that users regularly check for updates and newer versions.

StoreNext Retail Technologies LLC has prepared this manual for use by users, authorized third parties and personnel of StoreNext Retail Technologies LLC as a guide to the proper installation, operation, customization and/or maintenance of StoreNext Retail Technologies LLC equipment and software. The drawings and specifications contained herein are the property of StoreNext Retail Technologies LLC and/or its licensors.

Third-party products, services, or company names referenced in this document may be trademarked or copyrighted by their respective owners, and are for identification purposes only.

Copyrights, trademarks and license agreements shall be governed and construed in accordance with the laws of the State of Texas and the Federal Arbitration Act, and shall benefit Retailix, its successors, and assigns.

Address comments and corrections to:

StoreNext Retail Technologies LLC
Software Program Director
6100 Tennyson Parkway
Suite 130
Plano, Texas 75024

| | |
|--|------------------|
| <i>Document Control</i> | <i>e</i> |
| Distribution List — As per manuals | <i>e</i> |
| Changes Forecast | <i>e</i> |
| Change History | <i>e</i> |
| <i>Introducing the IBM SurePOS 500</i> | <i>1</i> |
| <i>SurePOS 500 Hardware</i> | <i>2</i> |
| Receiving and Unpacking the SurePOS 500 | <i>2</i> |
| Container..... | <i>2</i> |
| Take an Inventory | <i>3</i> |
| Assembly steps for the Touch SurePOS System | <i>5</i> |
| SureMark Printer..... | <i>5</i> |
| External Customer 2x20 display | <i>5</i> |
| IBM Cash Drawer | <i>5</i> |
| IBM 50-Key Keyboard | <i>6</i> |
| Putting the Pieces Together | <i>7</i> |
| Powering on the SurePOS | <i>9</i> |
| <i>Loading Drivers</i> | <i>11</i> |
| ELO Touch | <i>11</i> |
| PCI Serial Port Driver | <i>11</i> |
| OPOS | <i>12</i> |
| OPOS Installation - Screen Shots | <i>13</i> |
| Launch the setup wizard | <i>13</i> |
| Configuring and Testing OPOS - Screen Shots | <i>24</i> |
| Launch the Configuration Utility | <i>24</i> |
| <i>PSC 8200/8500 USB OPOS driver installation (if not using RS232 connection)</i> | <i>38</i> |
| <i>DataLogic 8200/8300/8400/8500 USB OPOS new driver installation (if not using RS232 connection)</i> | <i>38</i> |
| <i>HyperCom 4100/4150/4250 USB driver installation (if required)</i> | <i>43</i> |
| <i>ISS45 Installation</i> | <i>44</i> |
| <i>ISS45 Peripheral Setup for Connected Devices</i> | <i>54</i> |
| 50-Key POS Keyboard | <i>54</i> |
| ISS45 V7 Configuration | <i>54</i> |
| ISS45 V8 Configuration | <i>54</i> |
| 2x20 External Customer Display | <i>55</i> |
| ISS45 V7 Configuration | <i>55</i> |
| ISS45 V8 Configuration | <i>55</i> |
| IBM 4610-DG4 printer | <i>55</i> |

| | |
|---|-----------|
| ISS45 V7 Configuration | 55 |
| ISS45 V8 Configuration | 56 |
| PSC 8200 or 8500 USB Scanner and Scale configuration | 56 |
| ISS45 V7 Configuration | 56 |
| ISS45 V8 Configuration | 57 |
| Cash Drawer | 58 |
| ISS45 V7 Configuration | 58 |
| ISS45 V8 Configuration | 58 |
| MSR and Key Lock..... | 59 |
| ISS45 V7 Configuration | 59 |
| ISS45 V8 Configuration | 59 |
| HyperCom 4100/4150/4250 USB Pin Pad | 59 |
| ISS45 V7 Configuration | 59 |
| ISS45 V8 Configuration | 59 |
| <i>Further installation.....</i> | 60 |
| <i>Appendix A: Product Images.....</i> | 61 |
| <i>Appendix B: Keyboard layout for KBDKMAP.DAT file.....</i> | 64 |

Figures

| | |
|---|----|
| Figure 1: IBM SurePOS 500..... | 2 |
| Figure 2: Removing the Back Cover (1 of 2) | 7 |
| Figure 3: Removing the Back Cover (2 of 2) | 8 |
| Figure 4: IBM 4851 Back | 8 |
| Figure 5: IBM 4851 Power Switch | 9 |
| Figure 6: Launching UPOS Install..... | 13 |
| Figure 7: UPOS Install Welcome | 14 |
| Figure 8: UPOS License Agreementt | 15 |
| Figure 9: UPOS Customer Information Screen | 16 |
| Figure 10: UPOS Installation Type..... | 17 |
| Figure 11: UPOS Custom Install Screen | 18 |
| Figure 12: OPOS System Keyboard Screen | 19 |
| Figure 13: OPOS Adapter Card Screen | 20 |
| Figure 14: OPOS Install..... | 21 |
| Figure 15: OPOS Status | 22 |
| Figure 16: OPOS Install Completion..... | 22 |
| Figure 17: OPOS Reboot | 23 |
| Figure 18: Initial OPOS Configuration Screen..... | 24 |
| Figure 19: Configuring the Printer under the USB Tab..... | 25 |
| Figure 20: Naming the Printer | 26 |
| Figure 21: Configuring the MICR | 27 |
| Figure 22: Naming the MICR | 28 |
| Figure 23: Configuring the 50-Key Keyboard..... | 29 |
| Figure 24: Configuring the keyboard keylock..... | 30 |
| Figure 25: Items on the SurePOS 300/500/600, Kiosk Tab..... | 31 |
| Figure 26: Configuring the Cash Drawer..... | 32 |
| Figure 27: Naming the Cash Drawer | 33 |
| Figure 28: Configuring the Line Display..... | 34 |
| Figure 29: Naming the Line Display | 35 |
| Figure 30: Configuring the System Tone..... | 35 |
| Figure 31: Naming the System Tone | 36 |
| Figure 32: Firmware Being Updated at Boot Time | 37 |
| Figure 33: SurePOS 500 System | 61 |
| Figure 34: 50-Key Keyboard | 61 |
| Figure 35: IBM 4610-DG4 Printer | 62 |
| Figure 36: IBM 2x20 Customer Display | 62 |
| Figure 37: IBM Cash Drawer | 62 |
| Figure 38: IBM 4820-5GN Touch Flat Panel | 63 |

Document Control

Distribution List — As per manuals

Changes Forecast

This document will be updated as new configurations and corrections are made available

Change History

Issue 1: This is the initial release of this document.

Issue 1a: Added Document Control section
Added page numbers

Issue 1b: Updated POS Keyboard Figure 23 and directions

Added new section for the DataLogic USB OPOS new driver installation page 38

Updated 50-Key POS Keyboard page 54 about copying KBDKMAP.DAT

Removed reference to the Epson TM-H6000IIU that was in section 0.2.26.10 page 56

Enlarged the Keyboard layout file in Appendix B: Keyboard layout for KBDKMAP.DAT file.

Introducing the IBM SurePOS 500

The IBM SurePOS 500 (4851-E14) bundle that is available to StoreNext has one basic configuration either allowing Touch as the Primary Input or a combination of Touch and Keyboard as the primary input. This bundle does not support Dual Video. The SurePOS 500 comes preloaded with Microsoft WEPOS and the current set of IBM peripheral drivers. Appendix 'B' contains a list of these drivers. IBM UPOS is supplied on the hard drive, but is not loaded. Please replace it with the current version that can be found on the StoreNext FTP site. Install and configure it by using the sections labeled 'OPOS Installation – Screen Shots' and 'Configuring OPOS – Screen Shots'. These sections contain step by step information relating on how to load and configure OPOS.

The following are 'fast path' steps to assist you in receiving, inventorying and assembling the SurePOS 500 system and peripherals.

SurePOS 500 Hardware

The IBM SurePOS 500 bundle includes an SurePOS 500 (4851-E14), a 50-Key Keyboard (not shown), a two Station IBM 4610-DG4 printer (the printer shown in this is a single station 4610-TF6), a 2x20 External Customer Display (not shown) and a Cash Drawer and Till.

Dual Video is not supported.



Figure 1: IBM SurePOS 500

Each piece that makes up the system is packed in separate boxes, within a single large over-pack. You should Inventory the entire shipment to make sure all pieces are present.

Receiving and Unpacking the SurePOS 500

Container

When you receive the SurePOS 500 and all the peripherals they will be packed into a single over-pack, possibly banded to a skid. There will be a box marked

“Open Me First” within the over-pack. In this box you will find cabling and , paperwork and the lock cylinders with a set of keys. Do not discard any of these items. Save the Golden Key as it is the only tool that will allow you to insert the lock cylinder into the cash drawer and the keyboard.

Remove the packing slip and validate the unit is complete. If there are pieces that are not noted (see the list below) then contact your distributor to make sure they were shipped. If, when you open the over-pack and take an inventory and you find pieces are missing, look for another box that may include them.

Save the boxes for use in shipment to your customer unless you use specially designed ones to fit the assembled POS system. It may be your plan to have some assembly completed at the customer site. If this is correct, make sure all the parts are repacked in a manner so they will not be lost. If assembly is to be done at the customer, we recommend the cables be left attached to the SurePOS 500 where possible and disconnected from the peripherals. This will ensure the cables are connected to the correct ports

Take an Inventory

The SurePOS 500 include the following. Make sure all these parts are included

- SurePOS Base Unit – 4851-E14
- Black Power Cable
- Ethernet Cable
- 50-Key POS Keyboard
- 50-Key POS USB Keyboard Cable
- 50-Key POS Keyboard Lock Cylinder and keys
- Distributed Character Display (2x20)
- Distributed Serial Character Display Cable
- SureMark Printer – 4610-DG4
- Powered USB Printer Cable with Red End
- Roll of Thermal Paper
- Slip Printer Ribbon
- Full Size Cash Drawer
- Distributed (long) Cash Drawer Cable
- Cash Drawer Fixed Till
- Cash Drawer Lock Cylinder and keys
- Gold Key for lock Cylinder installation

Assembly steps for the Touch SurePOS System

SureMark Printer

Unpack the SureMark Printer. In the box there should be a Powered USB cable with a red end, a small roll of thermal paper and a ribbon.

Remove the tape from the outside of the printer and make sure all pieces are still in tact. Open the front cover at the Document Insert Station and remove the shipping cardboard.

Turn the printer over and install the Powered USB cable into the port on the printer. It will fit only one way, with the metallic side of the cable visible from the bottom. Make sure it clicks into place.

Turn the printer back over and install the printer ribbon and the thermal paper you plan to ship with the unit. Make sure the thermal paper unrolls from the top towards the back. This orients the paper to print on the correct side. Feed the paper thru the opening in the back cover and close the cover.

External Customer 2x20 display

Open the box identified to include the 2x20 external display. In the box you will find the display, the pole and mounting base, the cradle and two plastic screws. In the box marked "Open Me First" there should be a black cable that has a 15-pin D Shell connector on one end and a square, modular, connector on the other.

Attach the cradle to the mounting base and run the cable from the opening in the base of the stand thru the top of the cradle. Make sure the square, modular, end is showing at the top of the cradle.

Plug the cable into the 2x20 and make sure it clicks into place.

Orient the Display into the cradle. Be cautious that it is set correct. It is designed to be able to tilt backwards. If it is attached incorrectly it will not tilt the right way. Snap the sides of the mounting base over the edges of the 2x20 and click it into place.

IBM Cash Drawer

Open the large box with the cash drawer and a smaller one with the cash drawer till. The cash drawer cable will be in the box with the drawer. In the box marked

“Open Me First” you will find a lock cylinder with two keys. You will also find a “Golden” key.

Install the lock cylinder by setting the drawer on table with the drawer end upward. Look into the cylinder to make sure the groove in the insert area is oriented vertically with the wider part at the top. If it is not, use a flat blade screwdriver to line it up. It is important as the lock cylinder fits into the groove. Fully insert the ‘Golden’ key into the lock cylinder. You will see an additional tumbler moved. Insert the cylinder into the drawer with the teeth of the key upward. The cylinder will seat where it is flush with the outside of the receptacle. Hold the cylinder in place and remove the key. Insert the silver key and turn it leftward to see if the drawer opens. If it does not, remove the cylinder and reinstall it.

IBM 50-Key Keyboard

Open the box with the 50-Key keyboard. Find the standard USB cable that attaches the printer to the POS. At one end of the cable is a standard USB “A” and the other a unique plug that fits into the keyboard. Plug the cable into the keyboard.

Install the lock cylinder by setting the keyboard on table. Look into the cylinder receptacle to make sure the groove in the insert area is oriented vertically with the wider part at the top. If it is not, use a flat blade screwdriver to line it up. It is important as the lock cylinder fits into the groove. Fully insert the ‘Golden’ key into the lock cylinder. You will see an additional tumbler moved. Insert the cylinder into the keyboard with the teeth of the key upward. The cylinder will seat where it is flush with the outside of the receptacle. Hold the cylinder in place and remove the key. Insert the silver key and turn it leftward to see if the cylinder turns. If it does not, remove the cylinder and reinstall it.

There should also be a package of key overlays that can be used to label the keys as appropriate.

When this is complete keep the “Golden” key secure as this will open all IBM drawers.

Putting the Pieces Together

Total system assembly at your customer's location will depend on the physical setup. However, for driver and application loading follow these steps.

Remove the Back Cover of the SurePOS 500 as shown here.

Rear cover – removing and replacing

1. Facing the rear of the system, press in on both sides **A**, and lift upward **B**, as shown in [Figure 47 on page 62](#) and [Figure 46](#), rotating the bottom of the cover toward the back **C**.
2. Lift outward to remove.

To replace, reverse the removal procedure.

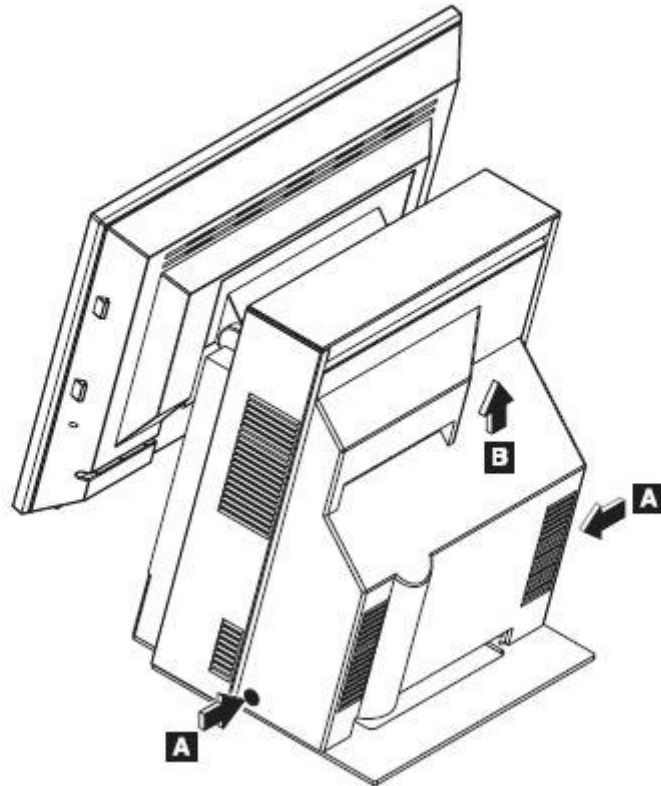

Figure 46. Rear cover removal

Figure 2: Removing the Back Cover (1 of 2)

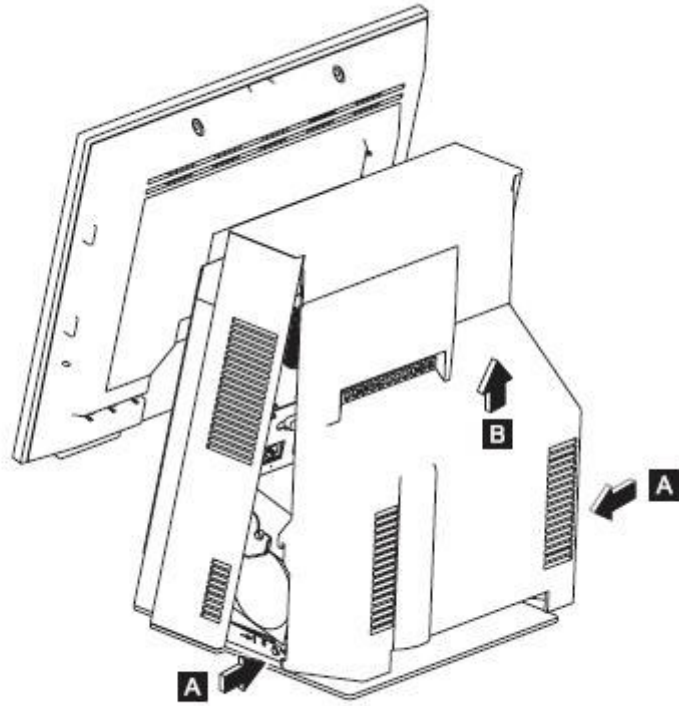

Figure 47. Unlatching rear cover

Figure 3: Removing the Back Cover (2 of 2)

The following is a picture of the back of the SurePOS 500 where the cabling attaches.

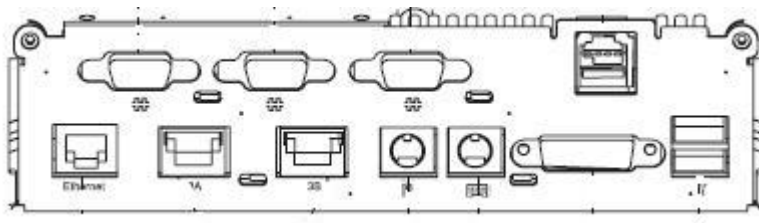

Figure 4: IBM 4851 Back

Make sure no power cables are plugged in to a wall outlet.

Place the SurePOS Cash Drawer on a table. Route the drawer cable thru the opening in the back cover and the top of the drawer.

Place the SurePOS 500 on the top of the drawer and plug the drawer cable into the port marked 3A.

Place the SureMark Printer on the top of the drawer and plug the Red ended Powered USB cable into the only 24V powered USB Port. It is the only Red port on the back of the unit.

Prop the 2x20 external customer display near the SurePOS and plug the black cable into the port marked with the image of a pole display. It is a 15pin D Shell connector on the back of the POS.

Plug the Ethernet cable into the port marked Ethernet.

You are now ready to power up the unit.

Powering on the SurePOS

The following is a picture of the right front bottom bezel edge of the SurePOS 500. The power and brightness controls are located here.

Powering on and the LED states

1. Plug the power cord into the SurePOS 500 Model 514 and then plug into an electrical outlet.

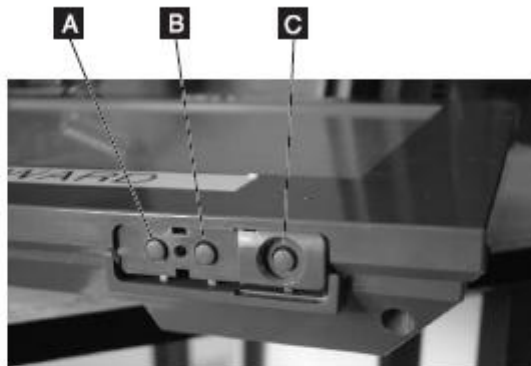

Figure 12. Location of power switch and screen brightness adjusting buttons

2. Power on the system using the power switch (**C** in [Figure 12](#)). The power light-emitting diode (LED) appears green.
3. Select the plus + (**A**) or minus - (**B**) buttons to adjust the screen brightness.
4. Verify that the system is operating correctly by checking the indicator lights (LEDs) on the front of the touch screen.

| | | |
|------------------------|---|---|
| Status/power indicator |  | <p>On: Logic working correctly. SourceACpower present and within tolerance.</p> <p>Off: The unit is powered off.</p> <p>Blinking: System is executing POST code</p> |
| HDD indicator |  | <p>On: HDD is reading or writing</p> <p>Off: No HDD activity</p> <p>Blinking: HDD is reading or writing</p> |

Figure 5: IBM 4851 Power Switch

Plug the Power cable into the SurePOS and plug it into a wall outlet and press the small Off / On button on the bottom right edge of the screen bezel.

You will see the Power on Self Test on the screen and also will hear the printer reset. If it does not, check the cable connections at the printer and the SurePOS 500. There is no Off / On Switch on the printer and the switches on the bottom of the printer do not function with a USB attached device.

You should also see a single line, like a cursor, on the external 2x20 customer display. If it is not visible, check the cable connections. It is plugged into a 15pin D Shell connector on the back of the POS.

At this point, if all devices are up and running you will be taken to the Windows Desktop. The Administrator password that is shipped with the preload is

wepos1!

It must be in lower case.

The next step is to load the necessary drivers.

Loading Drivers

NOTE: COPY ALL THE IBM DRIVERS AND INSTALLS FROM THE STORENEXT WEBSITE AND PLACE IN C:\DRIVERS ON THE IBM SUREPOS REGISTER SO YOU HAVE THE LASTEST CERTIFIED.

The SurePOS 500 (4851-E14) come preloaded with WEPOS, V1.1 and all the component level drivers that are required for it. There are additional drivers that you need to load. They are:

ELO Touch

Microsoft comes loaded with an ELO compatible driver, but we recommend loading the driver that is tuned for the IBM 4851 Flat Panel. The location of the latest touch driver is provided on the StoreNext Website.

PCI Serial Port Driver

This driver is required to enable all the serial ports above COM2. It may already be loaded. Look in the Device Manager to make sure COM1 – COM6 are enabled (Serial A – F). The location of the latest PCI Serial Port Driver is on the StoreNext Web site. Follow the instructions in the install to enable all 6 ports.

OPOS

The location of the latest UPOS Driver is located on the StoreNext Web site.

When you download the file, move it to the SurePOS 500 in any folder you wish and launch it. It is a .zip file and will expand into a folder in which there is a setup.exe. Run the setup and follow the screen shots that are following.

OPOS Installation - Screen Shots

Launch the setup wizard

The following screen appears preparing the installation.

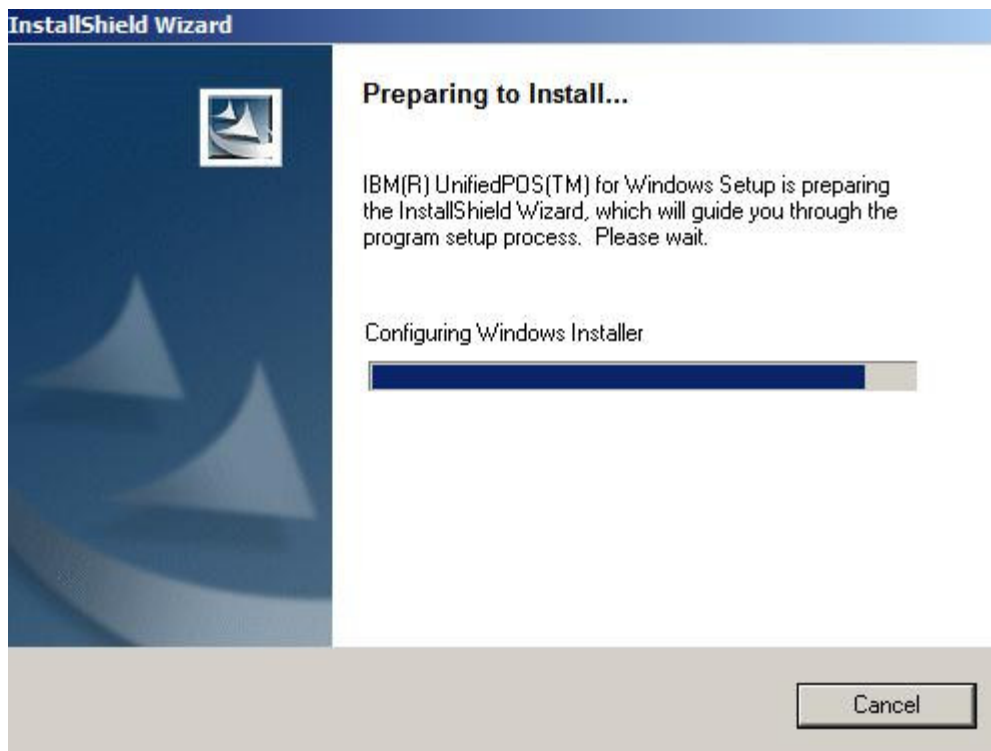

Figure 6: Launching UPOS Install

Click on **Next >** when the following appears.

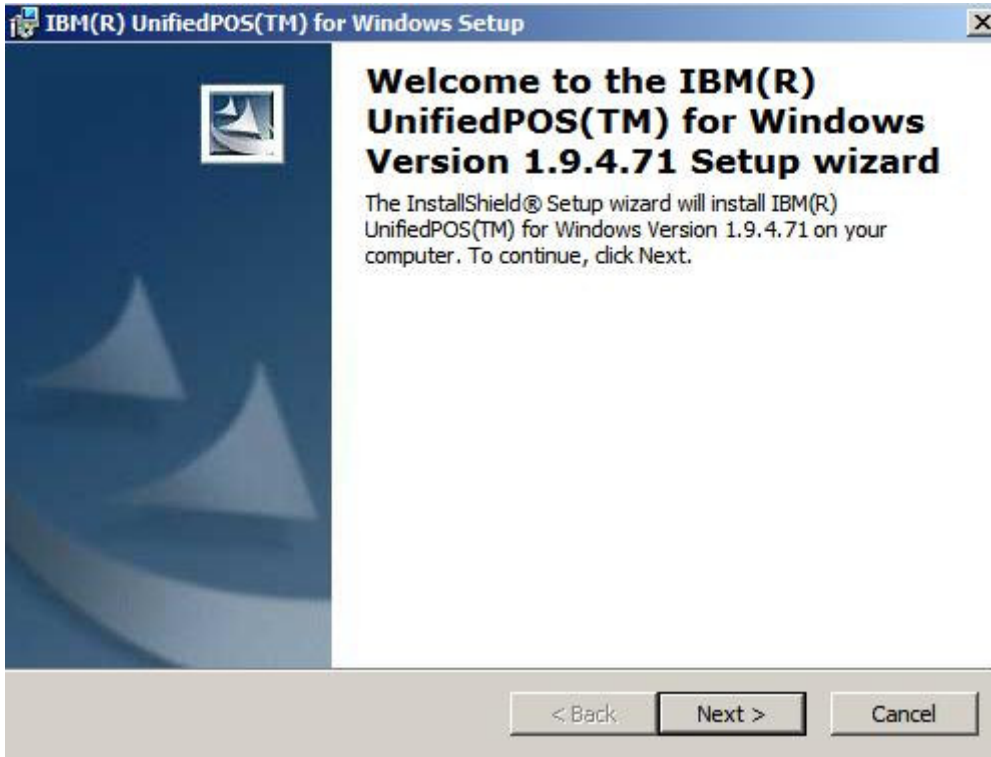

Figure 7: UPOS Install Welcome

Accept the license agreement and click on **Next >**



Figure 8: UPOS License Agreement

Change the User Name and Organization to match the one you are setting up. Leave the Install to: defaulted to C:\POS\ and click on **Next >**

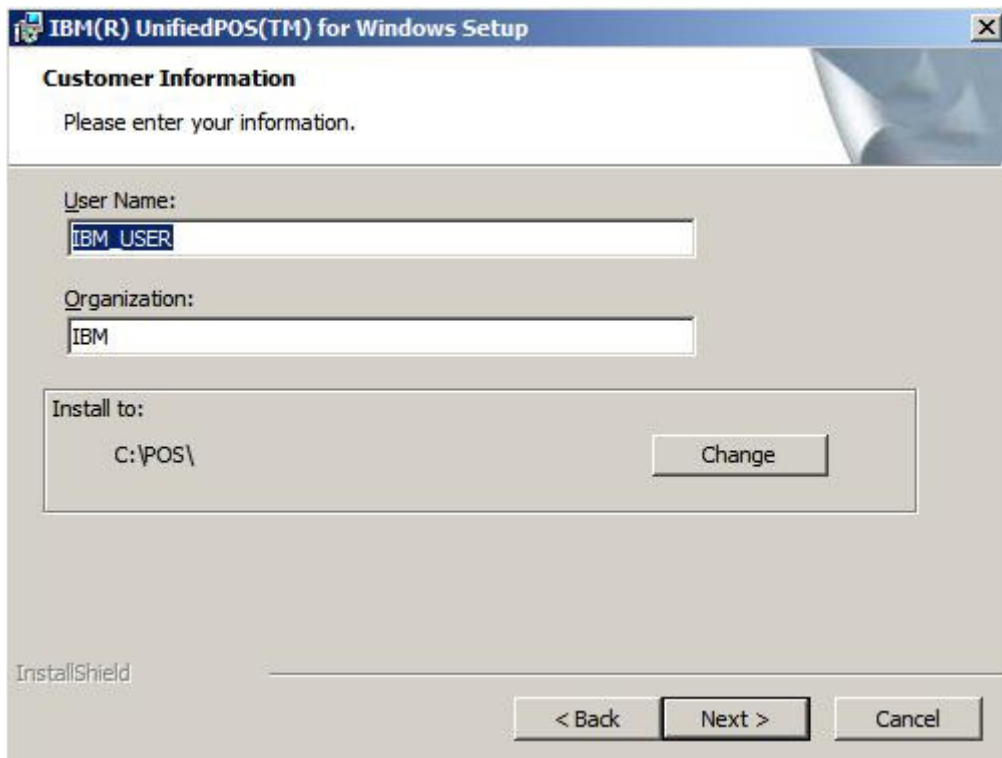

Figure 9: UPOS Customer Information Screen

The next screen will allow you to pick the installation type. Check only OPOS Device Support and when you do the screen will expand to include the products and other checkboxes. Do not check the check box labeled “Check to Install Java JRE and JCOMM”.

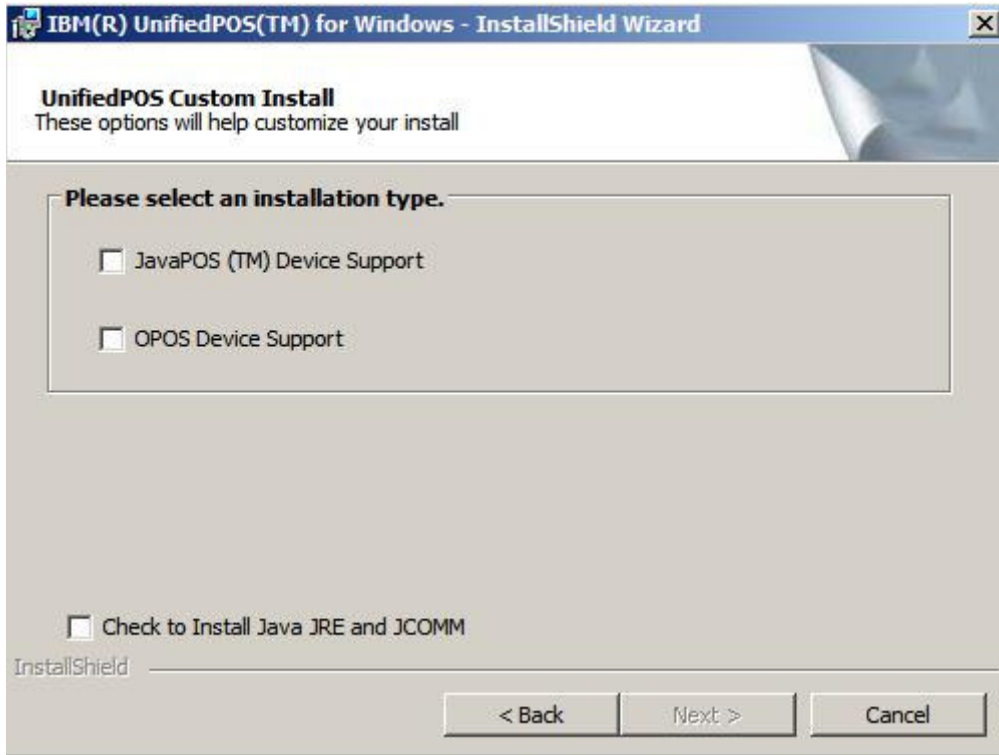

Figure 10: UPOS Installation Type

On this screen, place a check in the checkbox labeled OPOS Printer Firmware Update and OPOS common Control Objects. Also make sure the radio button beside SurePOS 500/600 & Kiosk (Other) is selected. Again, do not place a check in the checkbox labeled Check to Install Java JRE and JCOMM. Then click on **Next >**

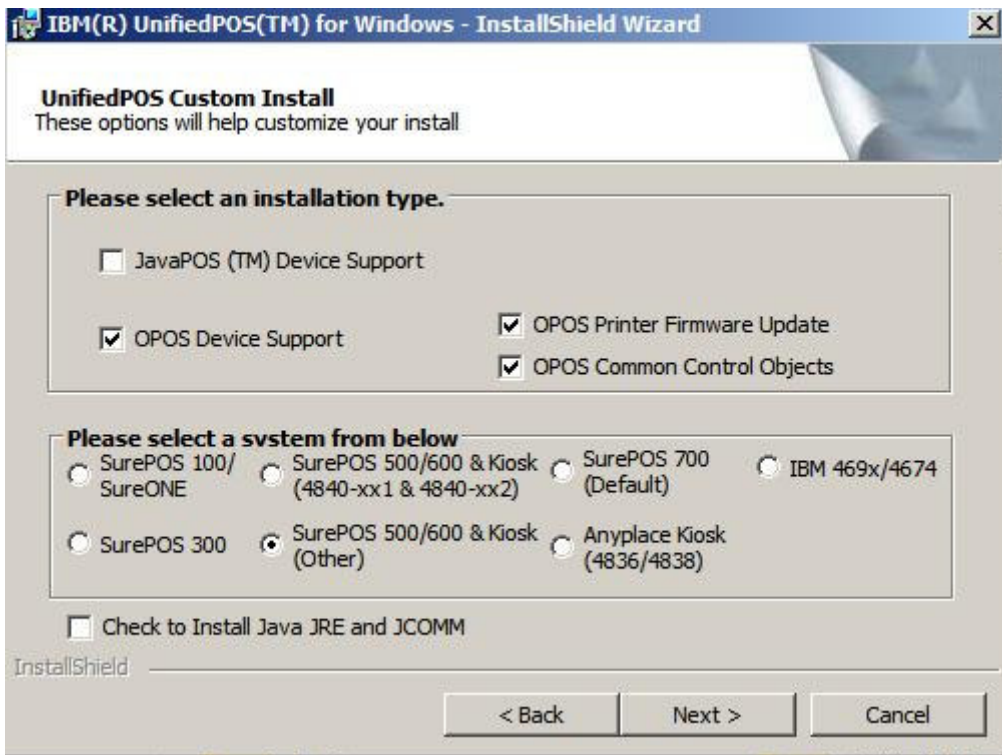

Figure 11: UPOS Custom Install Screen

You do not have an IBM Alphanumeric Point of Sale Keyboard so make sure the radio button beside No is selected, then click on **Next >**

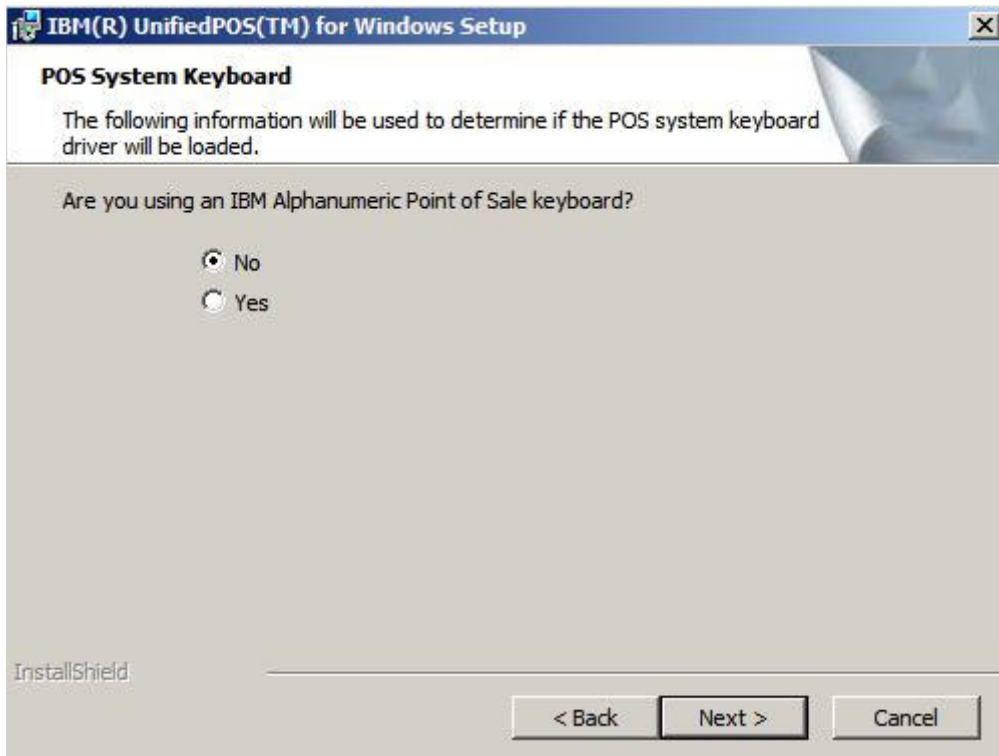

Figure 12: OPOS System Keyboard Screen

You do not have a 7497 POS Adapter card installed so make sure the radio button beside No is selected, then click on **Next >**

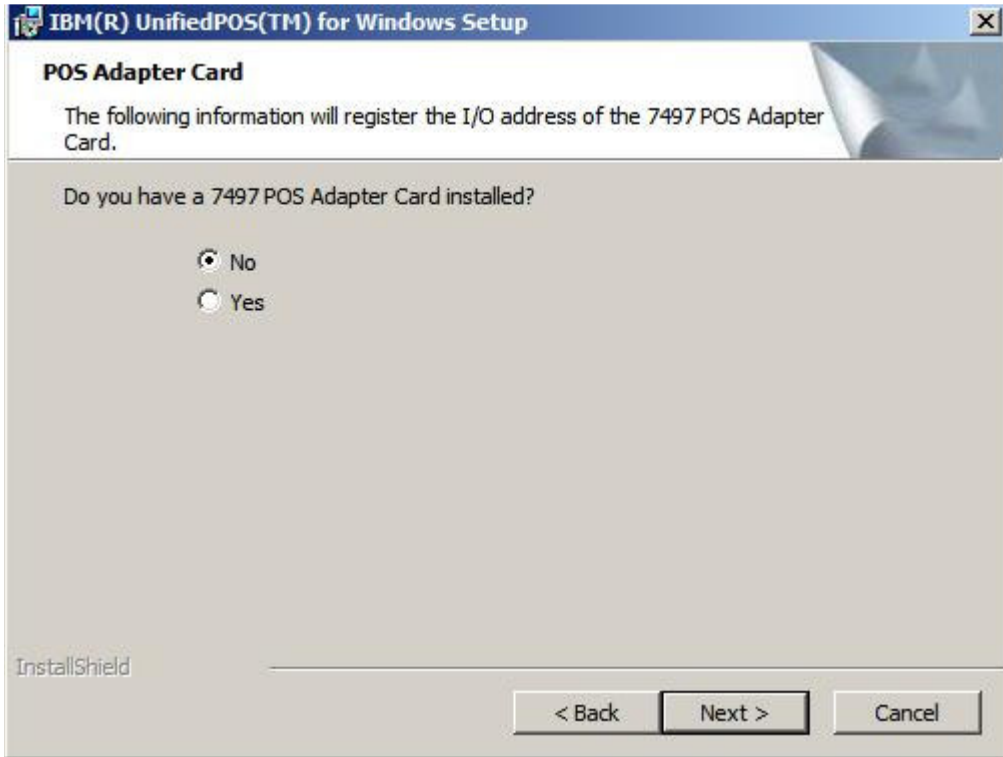

Figure 13: OPOS Adapter Card Screen

Click **Install** to perform the OPOS installation.

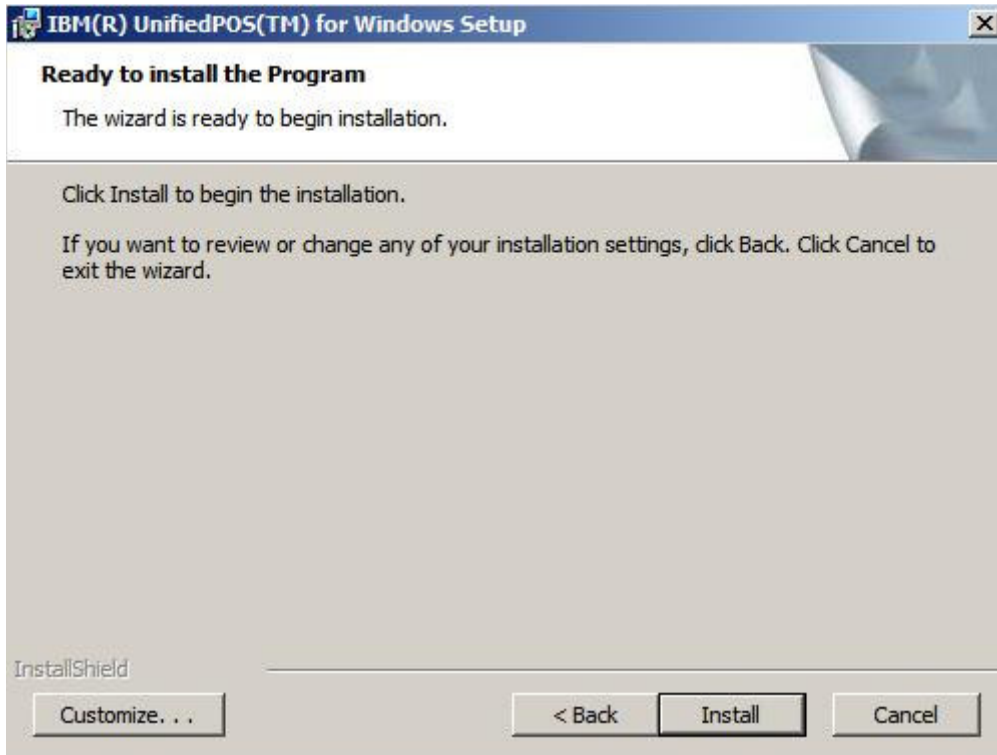

Figure 14: OPOS Install

As the installation progresses there is a status indicator present.

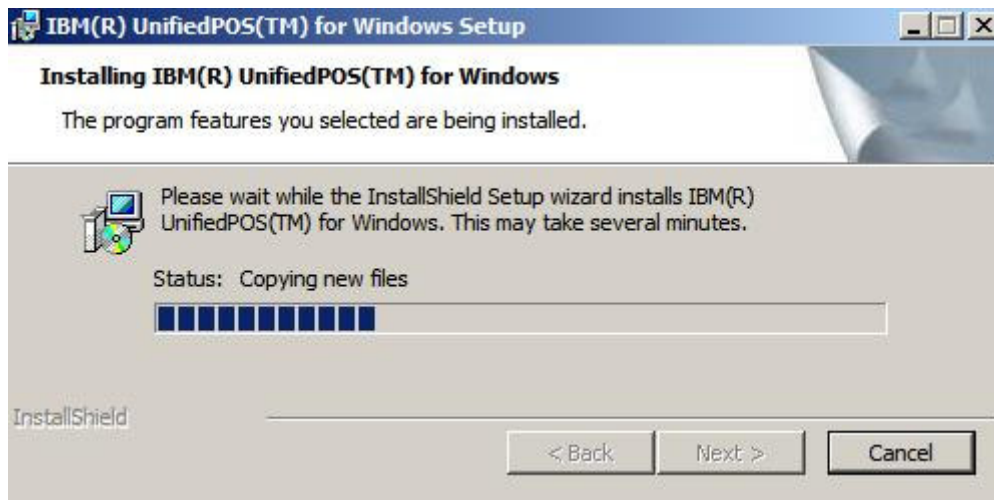

Figure 15: OPOS Status

When the installation is complete, click **Finish**



Figure 16: OPOS Install Completion

You will need to reboot the SurePOS 500 at this time, so click **Yes**

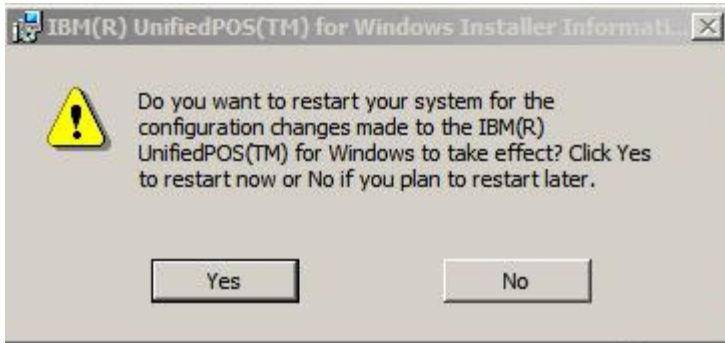

Figure 17: OPOS Reboot

After the SurePOS 500 has rebooted and is at the Windows Desktop you may see a window appear indicating the printer firmware is being updated. Both lights on the top of the printer will flash. Please **DO NOT** stop this action and **DO NOT** turn the system off. The printer firmware, including the boot sector, is being updated. Shutting it down too soon may damage the printer. This operation may take up to two minutes. The message will disappear and the printer will reset and the blinking lights will now remain lit constantly.

Configuring and Testing OPOS - Screen Shots

Launch the Configuration Utility

After you have loaded OPOS you must configure the devices so the application will recognize them and be able to use them. The following steps should be followed.

Click on “Start” in the task bar, then “All Programs”, then “IBM OLE for Point of Sale” then “Configuration Utility”. The following Screen will appear. Some items may already show up as on-line. However most should be in black and show up as Available.

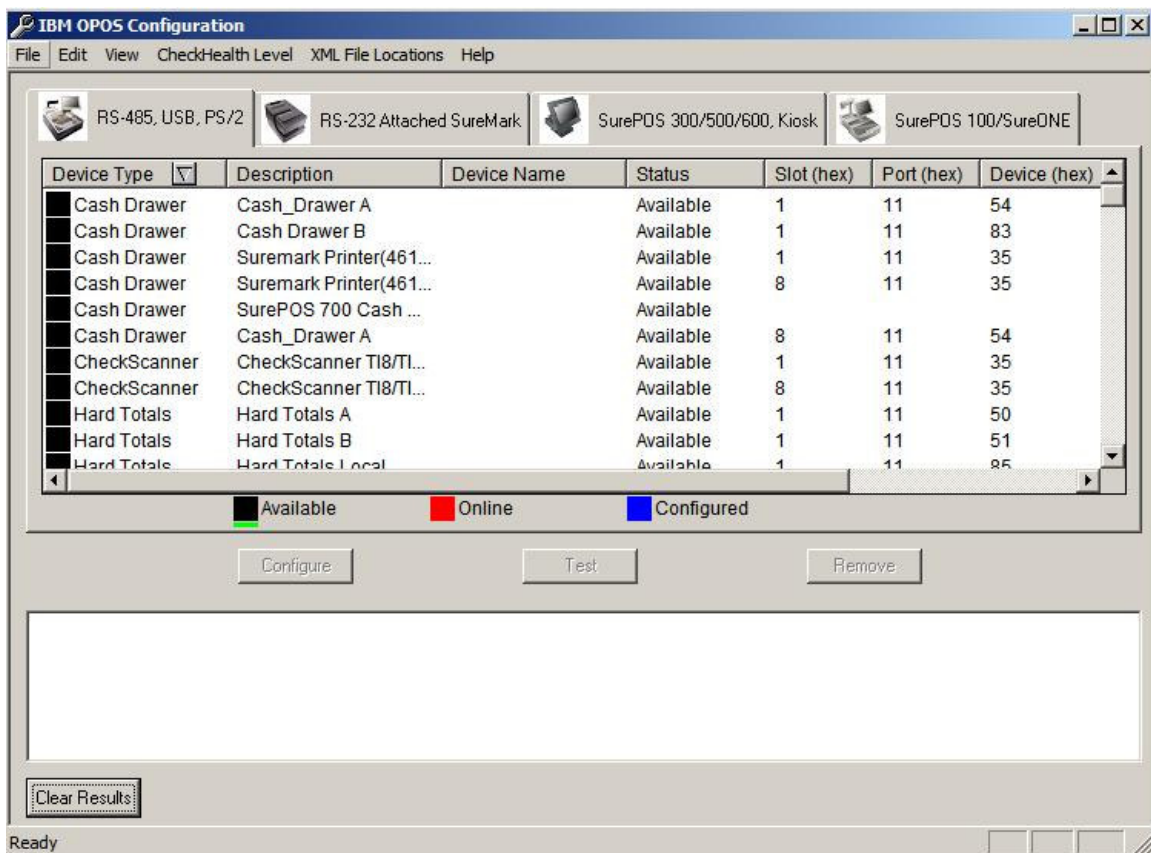

Figure 18: Initial OPOS Configuration Screen

Find the correct printer entry and highlight it. Click on Configure. A popup will display so you can name the printer. Accept the other defaults.

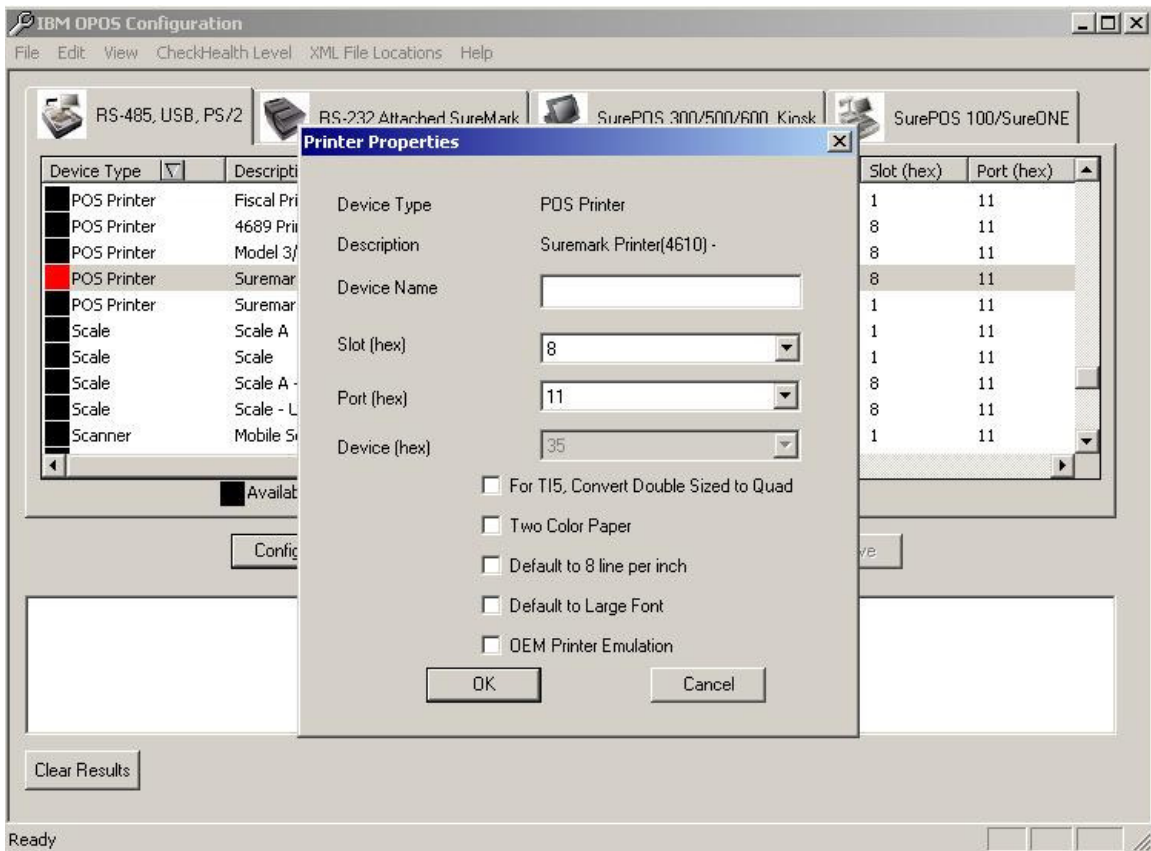

Figure 19: Configuring the Printer under the USB Tab

Type the name of the printer as seen below and click OK.

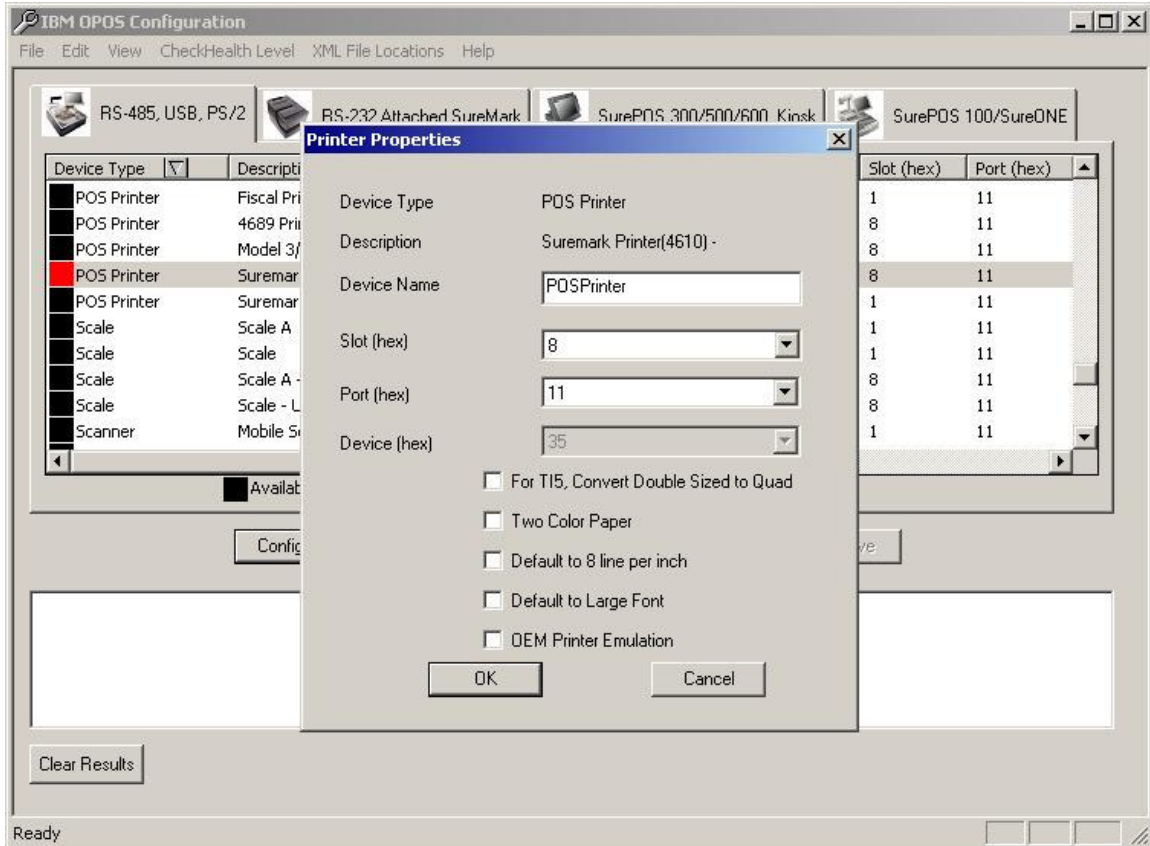

Figure 20: Naming the Printer

The configured printer will show up on the list and in Blue.

Highlight the MICR entry associated with the printer. The naming popup will show again.

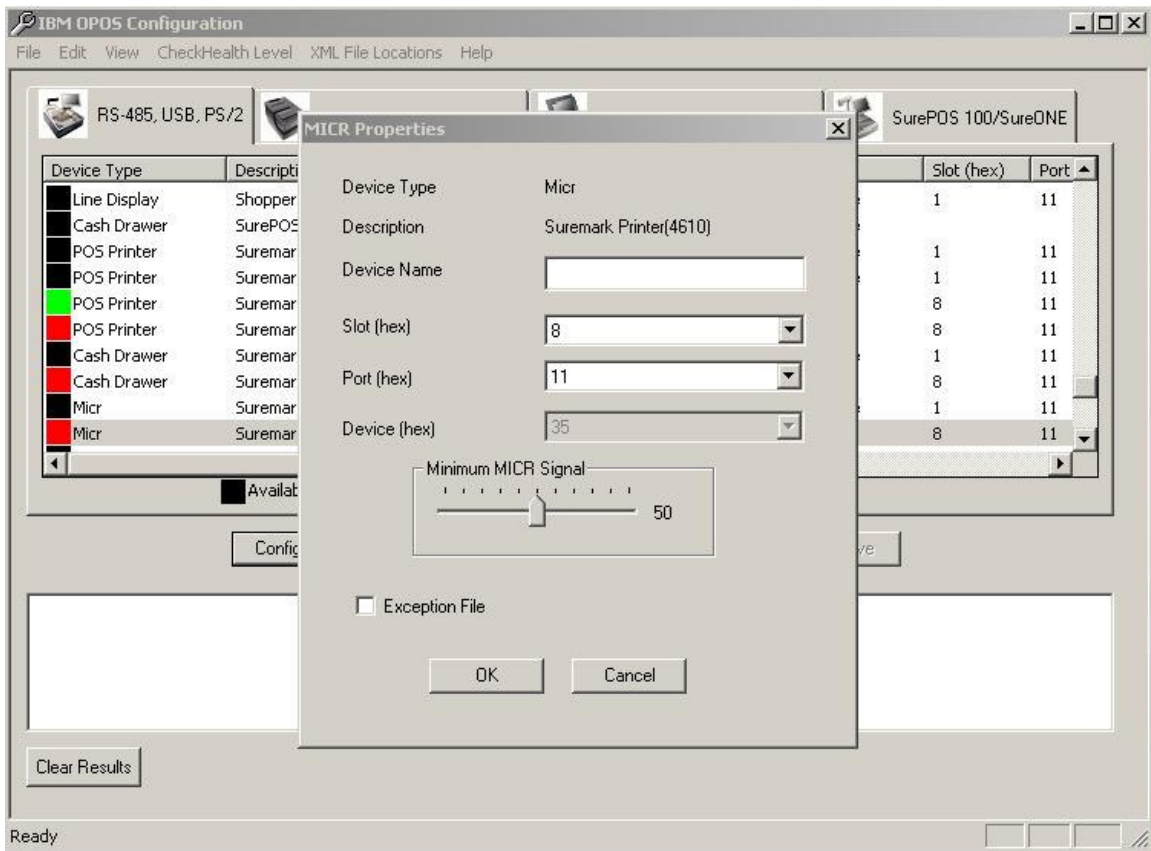

Figure 21: Configuring the MICR

Name the printer and check the checkbox Exception File, then click on OK.

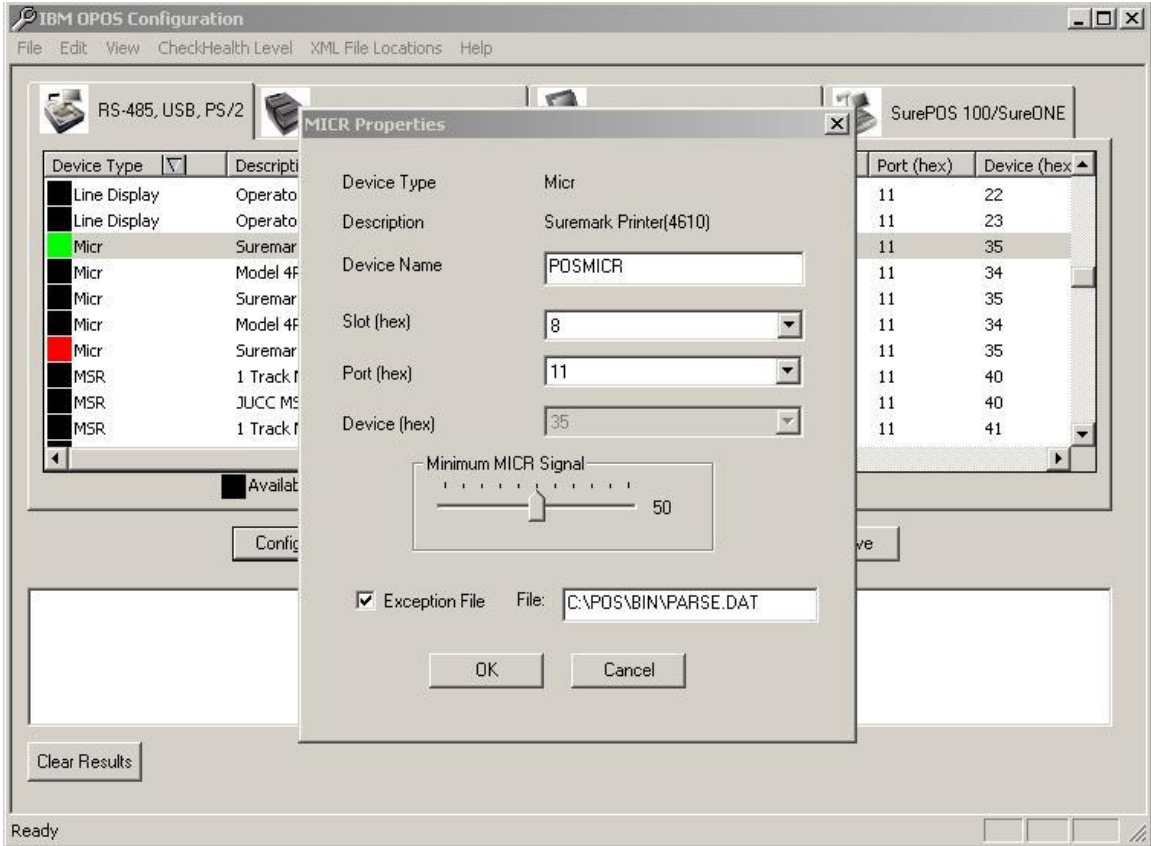

Figure 22: Naming the MICR

Click on the entry labeled POS Keyboard – A USB to configure the 50-Key Keyboard. **Enter Device Name POSKybd and check the box Map Pos Keys.** Make sure that the File is C:\POS\DLL\KBDKMAP.DAT then click OK.

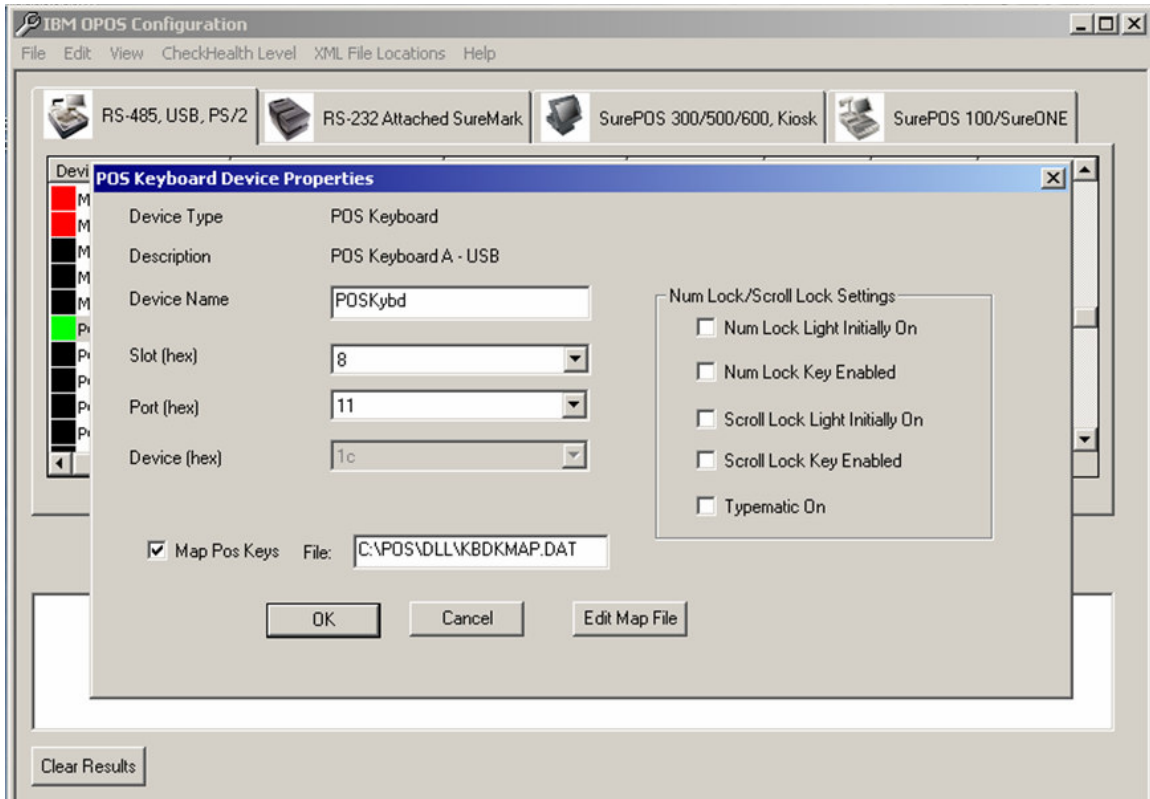

Figure 23: Configuring the 50-Key Keyboard

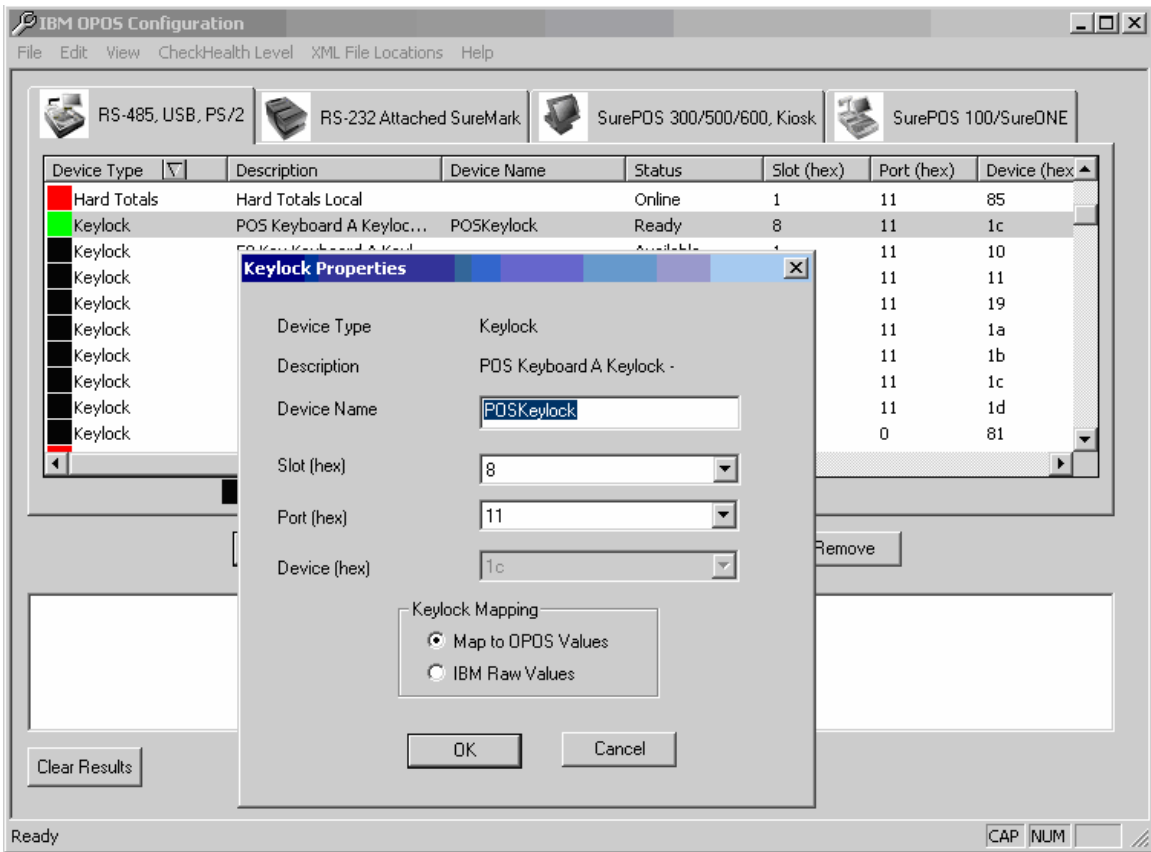

Figure 24: Configuring the keyboard keylock

Change to the tab labeled SurePOS 300/500/600, Kiosk. The entries will look like this.

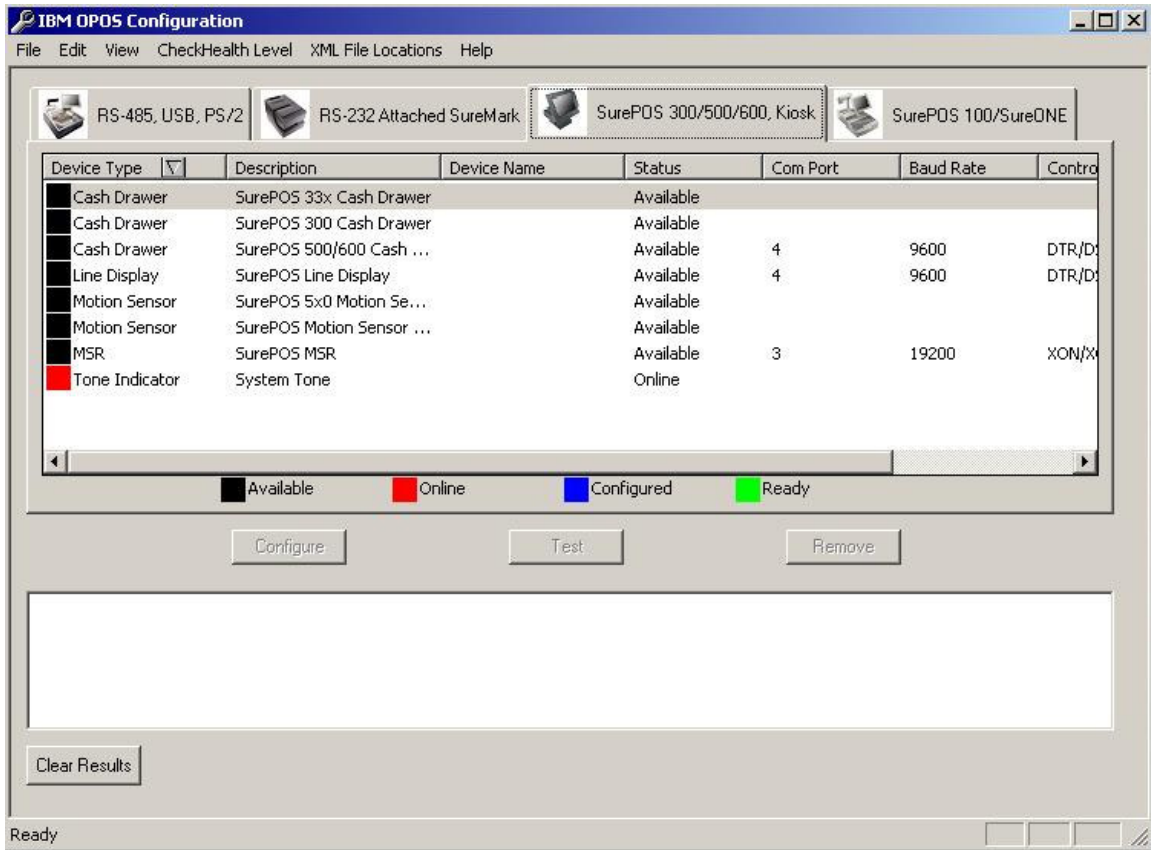

Figure 25: Items on the SurePOS 300/500/600, Kiosk Tab

Select the entry labeled SurePOS 33x Cash Drawer and click on Configure. The naming popup will appear.

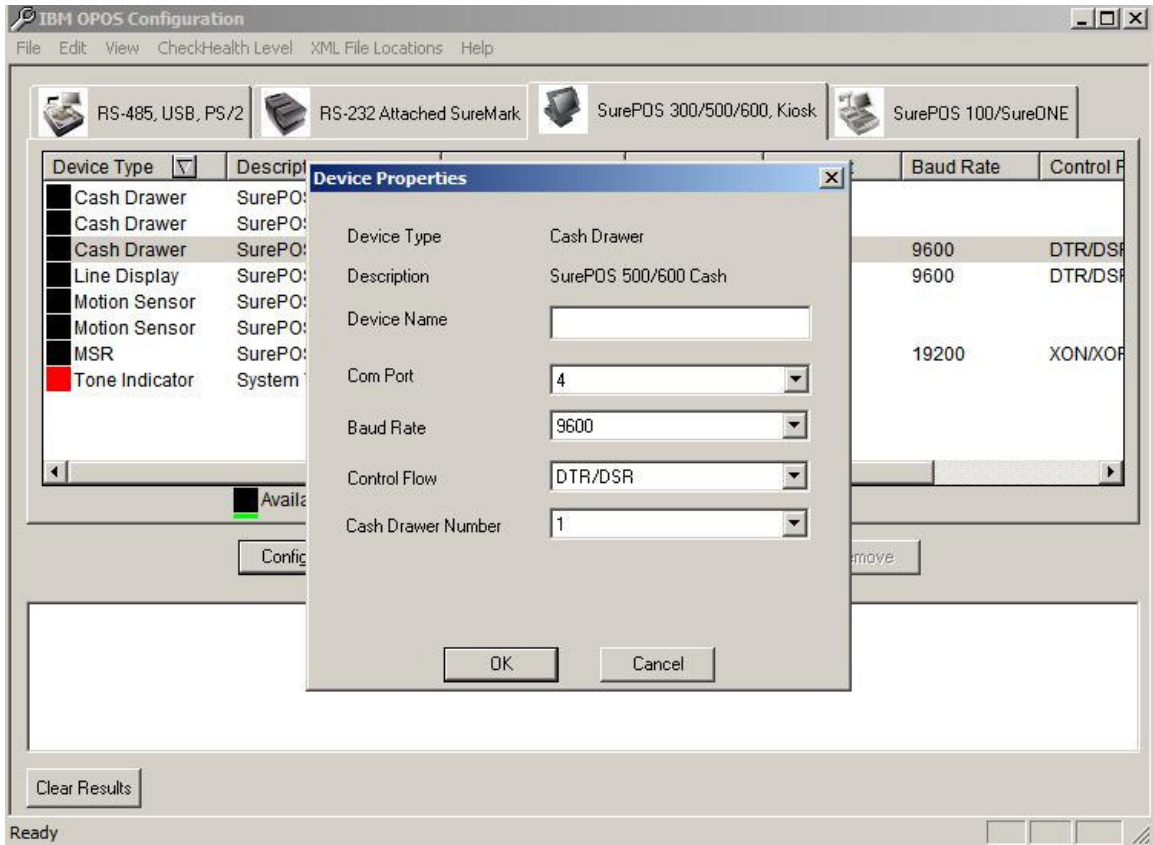

Figure 26: Configuring the Cash Drawer

Name the drawer as noted here and click on OK.

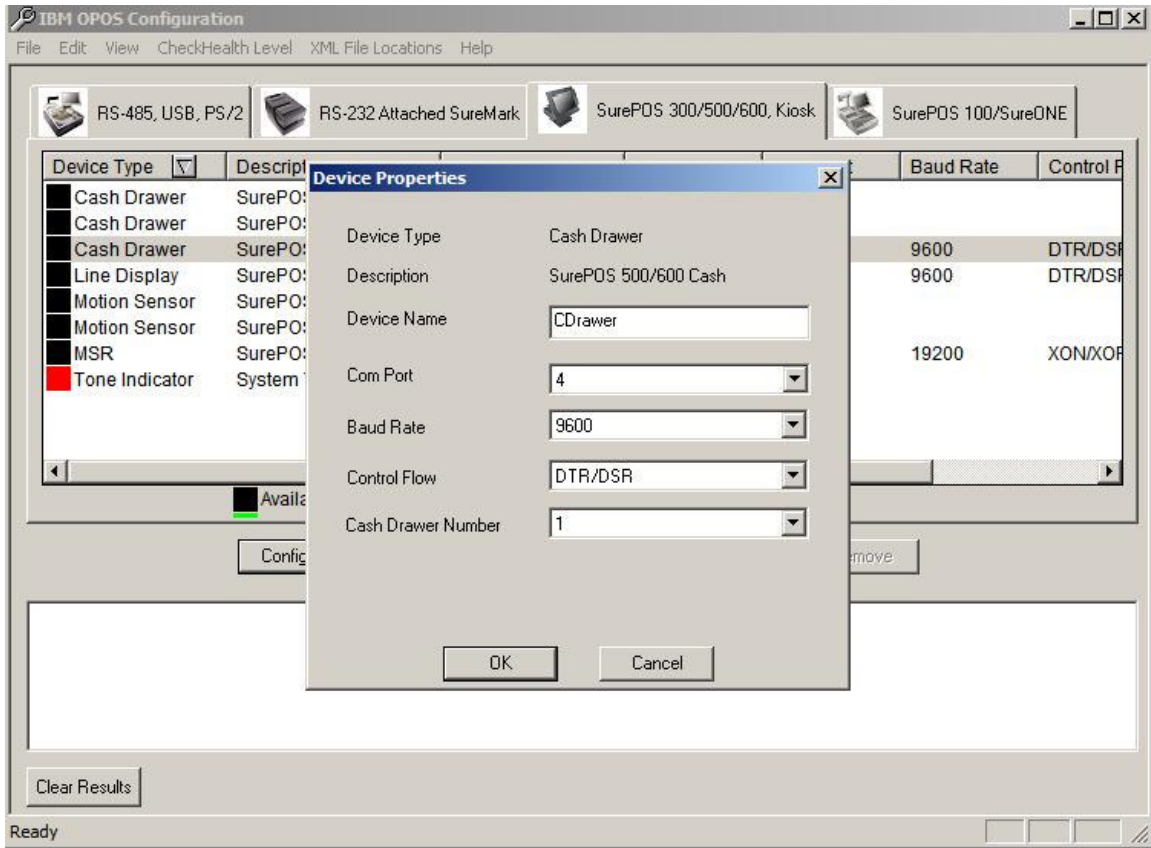

Figure 27: Naming the Cash Drawer

Click on the entry identified as the Line Display. The naming popup will appear.



Figure 28: Configuring the Line Display

Name the Line Display as indicated here. It is defaulted to COM 4.

Figure 29: Naming the Line Display

Click on the item identified as the Tone Indicator and then click on Configure. The naming popup will appear.



Figure 30: Configuring the System Tone

Name the System Tone entry as identified below and click on OK.

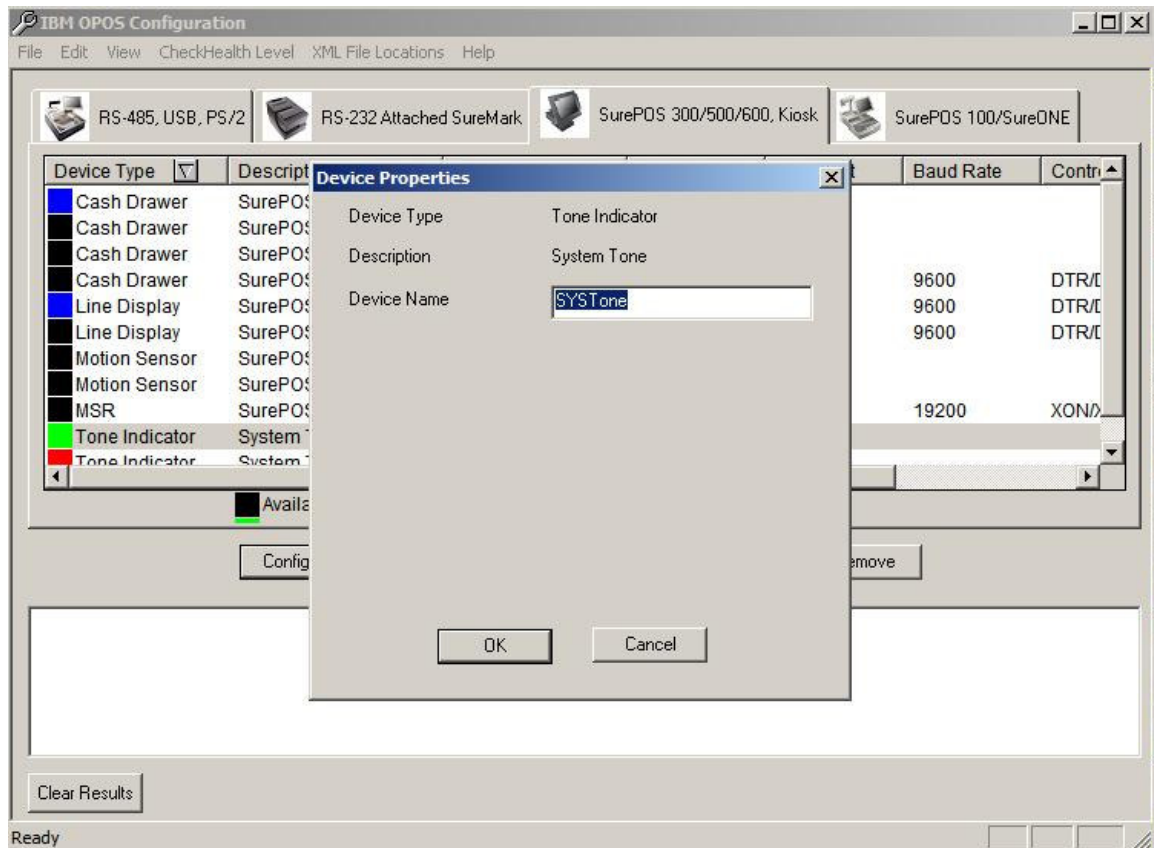

Figure 31: Naming the System Tone

At this point OPOS is completely configured for the IBM devices that are attached. Reboot the system. During the reboot, after the Windows Desktop

appears a message may be displayed, indicating the printer firmware is being updated. If this message does appear, both lights on the printer will flash together. Please follow the instructions in this message and DO NOT interrupt the update. When it is complete the message will disappear and the printer will reset. The message that appears is:



Figure 32: Firmware Being Updated at Boot Time

PSC 8200/8500 USB OPOS driver installation (if not using RS232 connection)

Note: The new driver in the following section will replace this old driver and can be used for the 8200/8300/8400/8500/6500/1000i DataLogic devices and resolves one issue not reading some UPC labels.

- 0.1.1. Scan the PSC Labels (switch then Interface Type = IBM-USB and then switch again)
- 0.1.2. Shutdown the SurePOS prior to plugging in the PSC Scanner/Scale
- 0.1.3. Plug the 12v powered USB cable into an available powered USB port on the back of the SurePOS
- 0.1.4. Turn on the SurePOS
- 0.1.5. The device will be discovered by the operating system and install it as a HID device
- 0.1.6. Run the program
PSC_OPOS_USB_Installation_1_8_0_34_28Feb2007.exe located on the V7 or V8 distribution CD in the OPOS\PSC folder to install the OPOS for the PSC Scanner/Scale
- 0.1.7. After the restart has completed, run PSC OPOS Configuration by clicking from the desktop "Start>All Programs>PSC_OPOS>PSC OPOS Configuration"
 - 0.1.7.1. Click Read
 - 0.1.7.2. Make sure English, Zero Valid and ASCII are selected and click Write

DataLogic 8200/8300/8400/8500 USB OPOS new driver installation (if not using RS232 connection)

- 0.1.8. Scan the PSC Labels (switch then Interface Type = IBM-USB and then switch again)
- 0.1.9. Shutdown the SurePOS prior to plugging in the PSC Scanner/Scale
- 0.1.10. Plug the 12v powered USB cable into an available powered USB port on the back of the SurePOS
- 0.1.11. Turn on the SurePOS
- 0.1.12. The device will be discovered by the operating system and install it as a HID device
- 0.1.13. Run the program
DATALOGIC_OPOS_Installation_1_8_08May2008_ScanMaster_ISS45.exe located on the StoreNext Web site
- 0.1.14. The following DATALOGIC OPOS Service Objects 08May2008 1.8 welcome screen is displayed

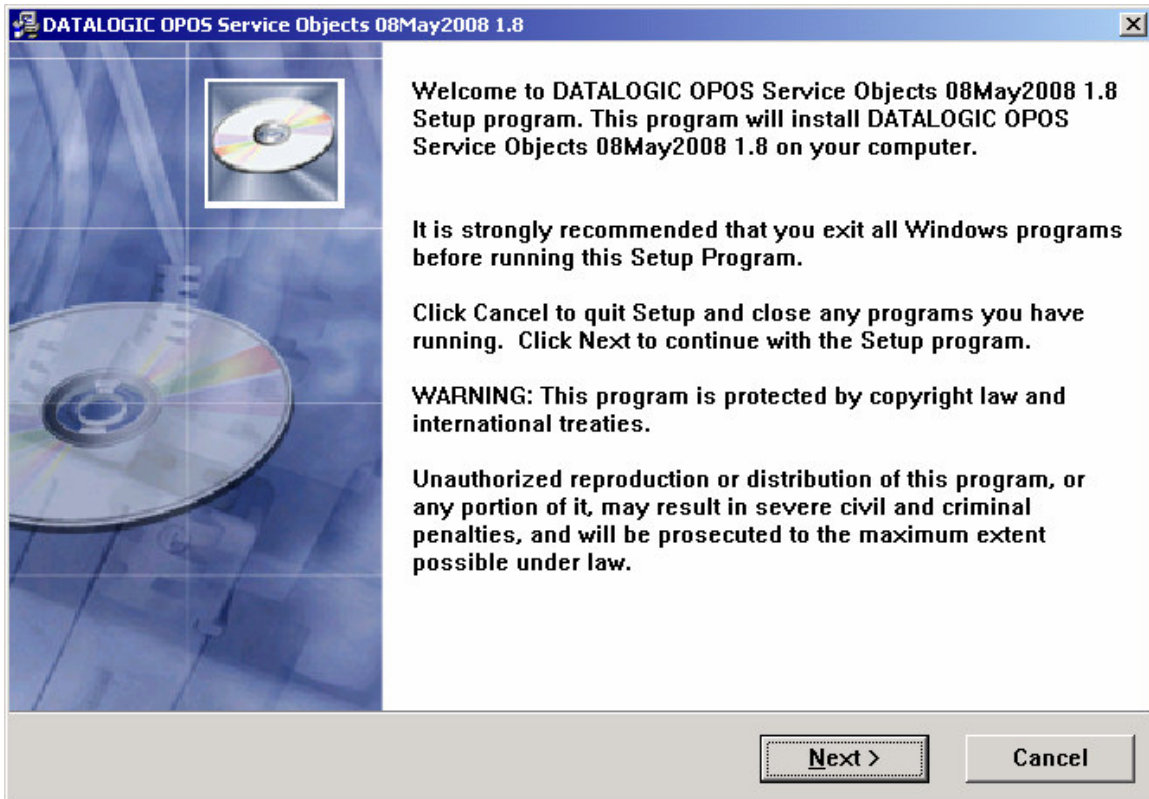

0.1.15. Click Next and the License Agreement screen is displayed

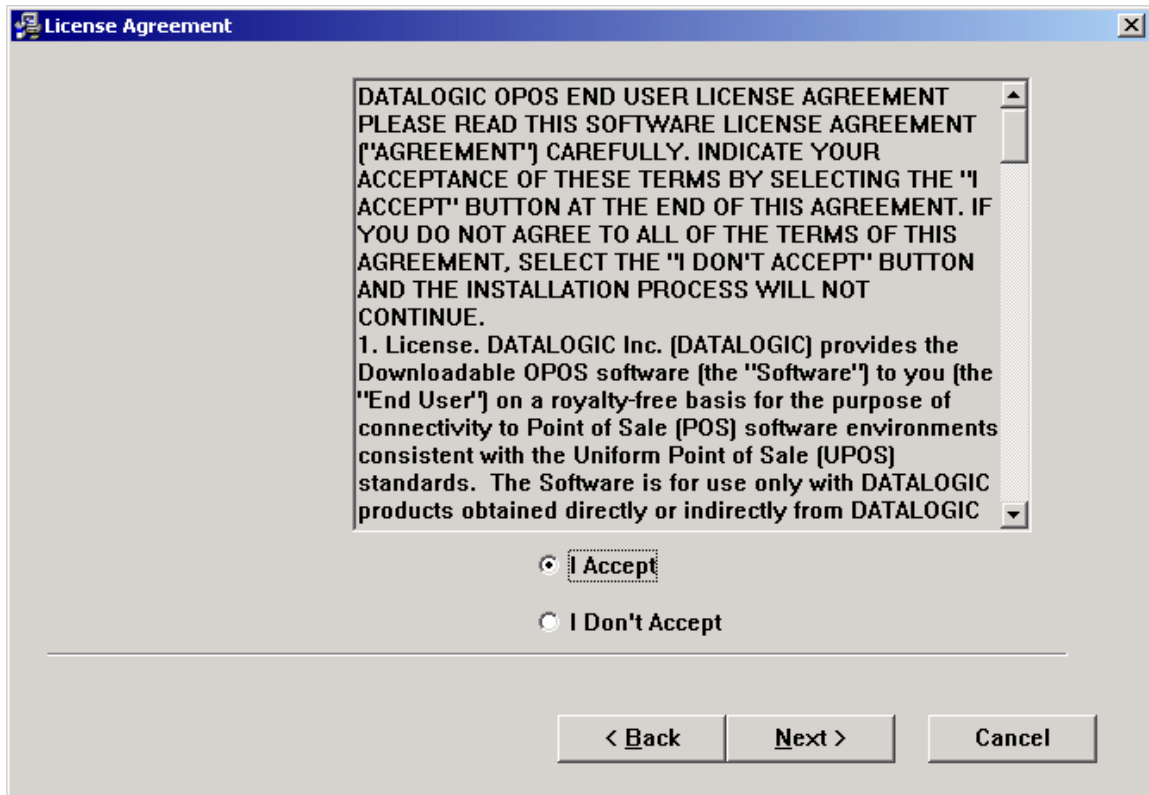

0.1.16. Click I Accept, click Next and the Destination Location screen is displayed

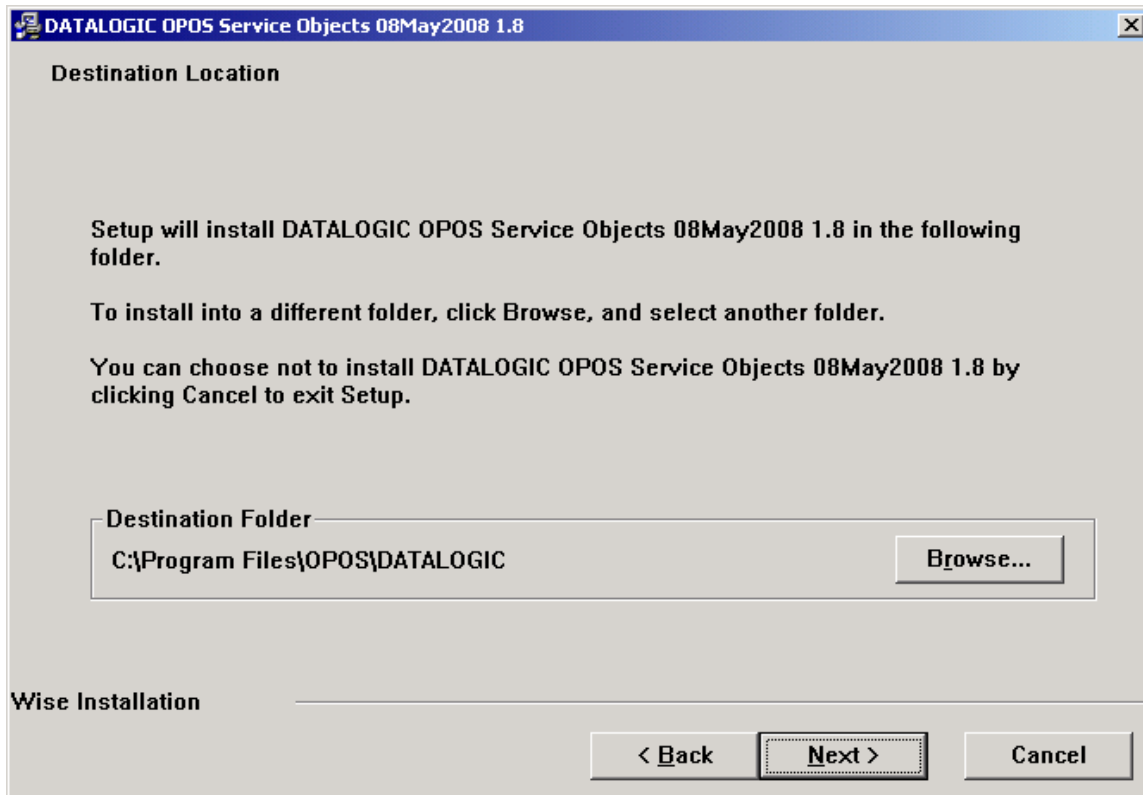

0.1.17. Click Next and the Backup Replaced Files screen is displayed

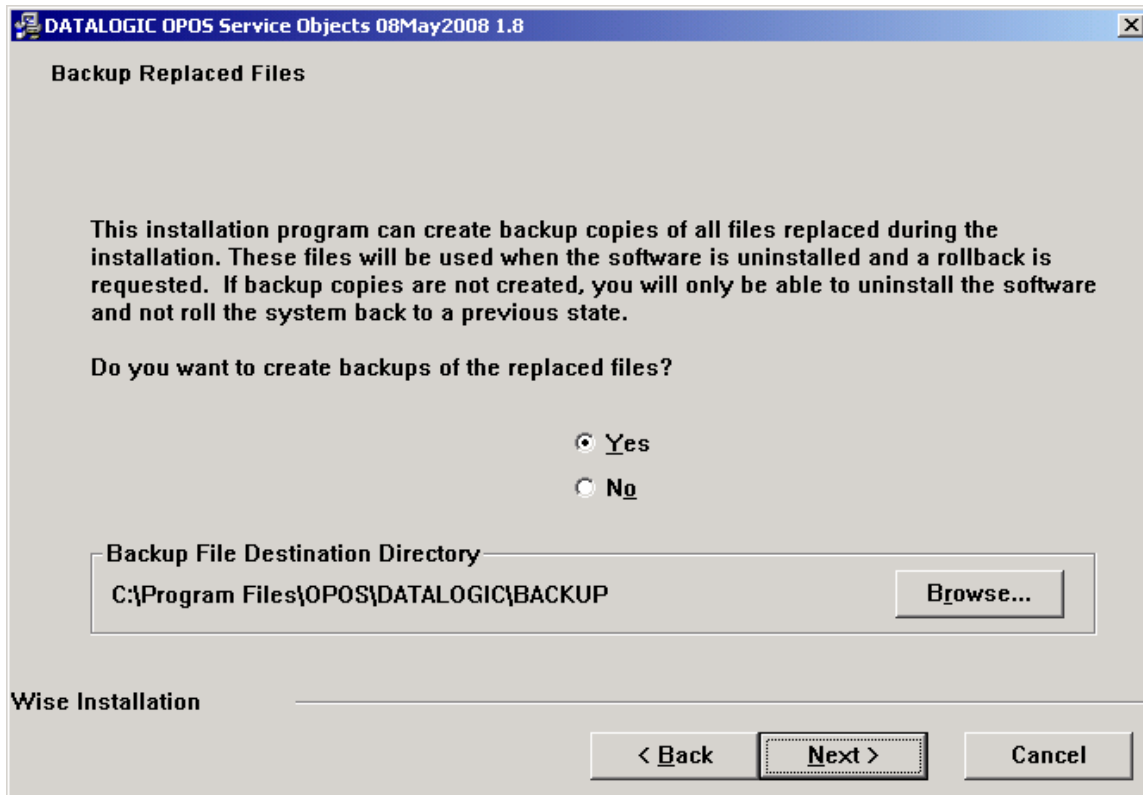

0.1.18. Click Next and the Select Components screen is displayed

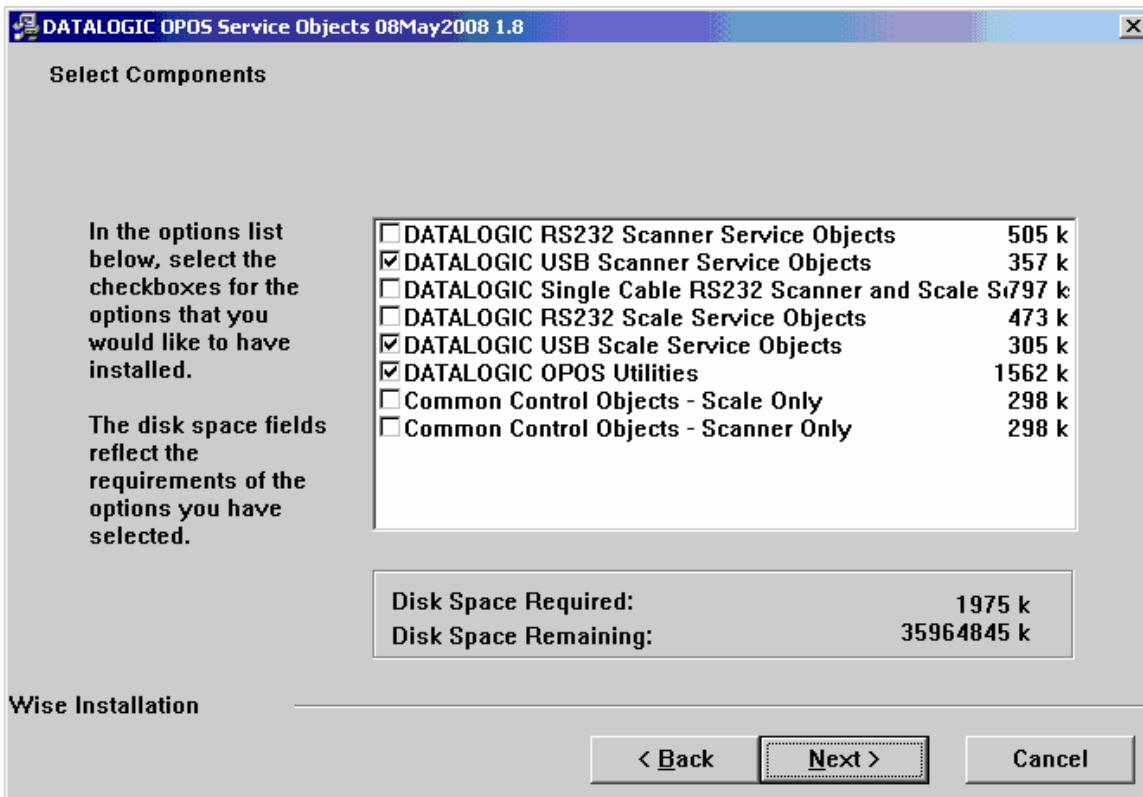

0.1.19. Uncheck all the RS232 selections as ISS45 software only uses OPOS on the USB connected Scanner/Scale. Leave the Common Control Objects uncheck since they are provided on the IBM SurePOS already. Click Next and the Start Installation screen is displayed

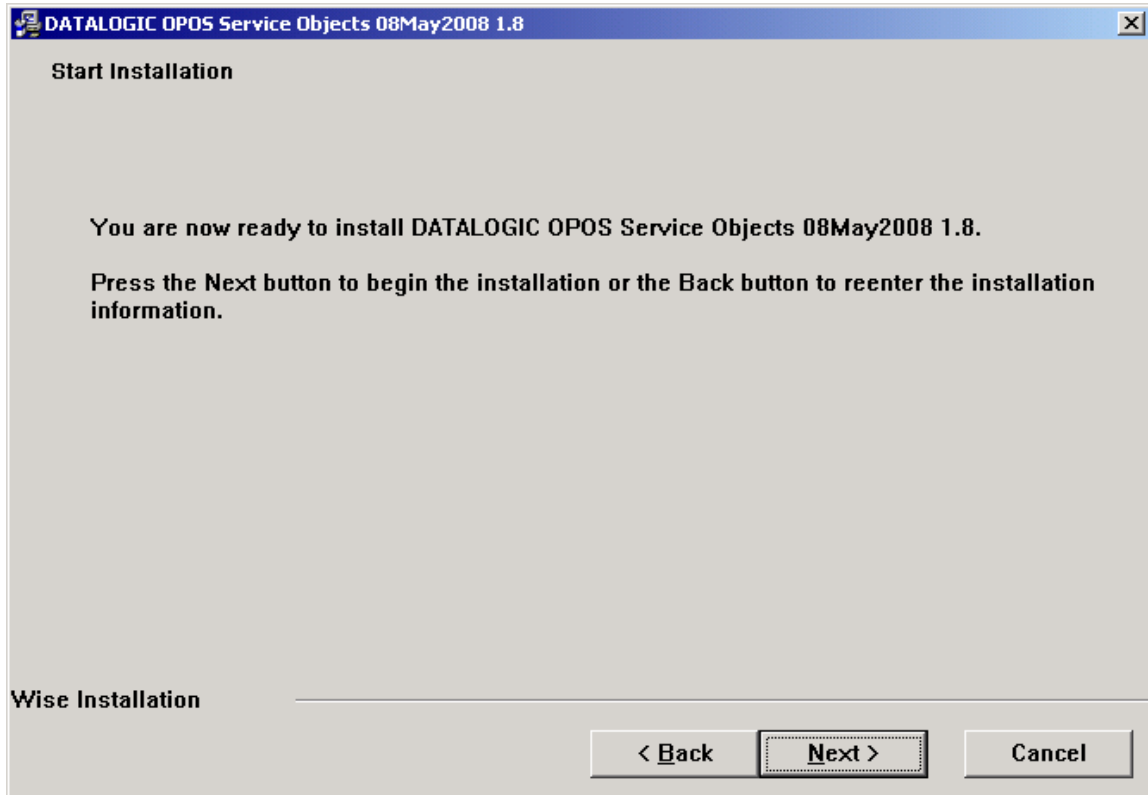

0.1.20. Click Next and the successfully installed screen is displayed

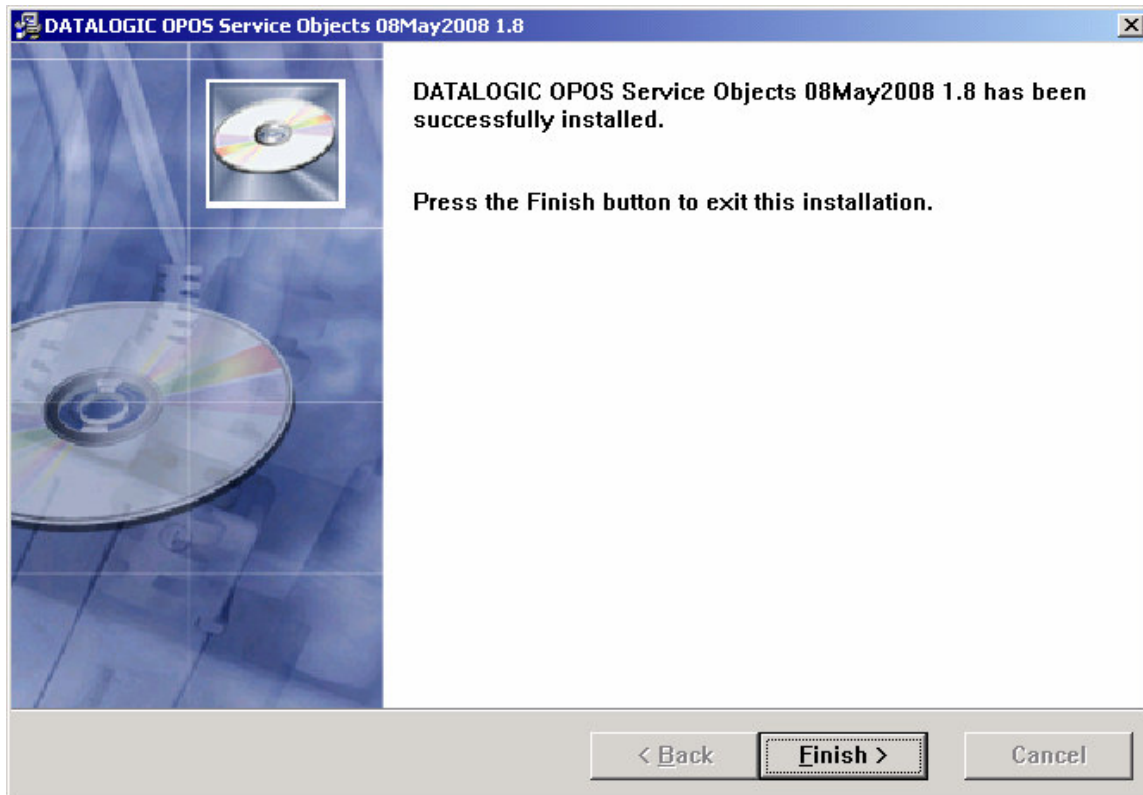

0.1.21. Click Finish to close the screen

HyperCom 4100/4150/4250 USB driver installation (if required)

Note: This section only applies if you are using a USB connected HyperCom 4100/4150/4250 EFT terminal

Software Installation

0.1.22. On the WinEPS installation CD, browse to the \OpenEPS\SCAT Code\Hyp4100 or 4250\ directory

0.1.23. Extract the "4100 USB Driver Installation (40_RS232ToUSBDriver).zip" file to a convenient location on the POST, such as the desktop

0.1.24. Run the RS232toUSBDriver.msi by double clicking on it

0.1.25. Click Next

0.1.26. Select I Agree and click Next

0.1.27. Use the default directory path during the installation

0.1.28. Select everyone

0.1.29. Click Next

0.1.30. Confirm the installation by clicking Next

0.1.31. You may see an error on the screen at this point of the installation but this can be ignored as it is part of the installation

0.1.32. Installation complete screen appears

Hardware USB Mode Setup

0.1.33. On the HyperCom, tap the upper left corner, upper right corner and the upper left corner again

0.1.34. If you are prompted for a password, enter "multilane" or "685845263" on the number pad

0.1.35. At the Main menu, select ERC Port

0.1.36. Under the ERC menu, select USB

0.1.37. Select USB and then press the apply now button

0.1.38. Reboot the HyperCom terminal

0.1.39. The startup screen should now list USB for the communication type

ISS45 Installation

0.2. Starting ISS45 WinPOS installation

0.2.1. Use the following to start the WinPOS installation from the ISS45 software release

0.2.2. Click Start | Run

0.2.3. Click on and locate the file Setup.exe in the CD Drive: folder WinPOS\Disk1 (example D:\WinPOS\Disk1 folder)

0.2.4. Double click on Setup which puts it into (Run – Open:
D:\WinPOS\Disk1\Setup.exe

CAUTION: Ensure that the line indicates Setup.exe and not Setup.bat
If the line indicates Setup.bat then browse back and select the correct Setup.exe file

0.2.5. Click to launch the WinPOS installation

0.2.6. The following (Welcome) screen is displayed

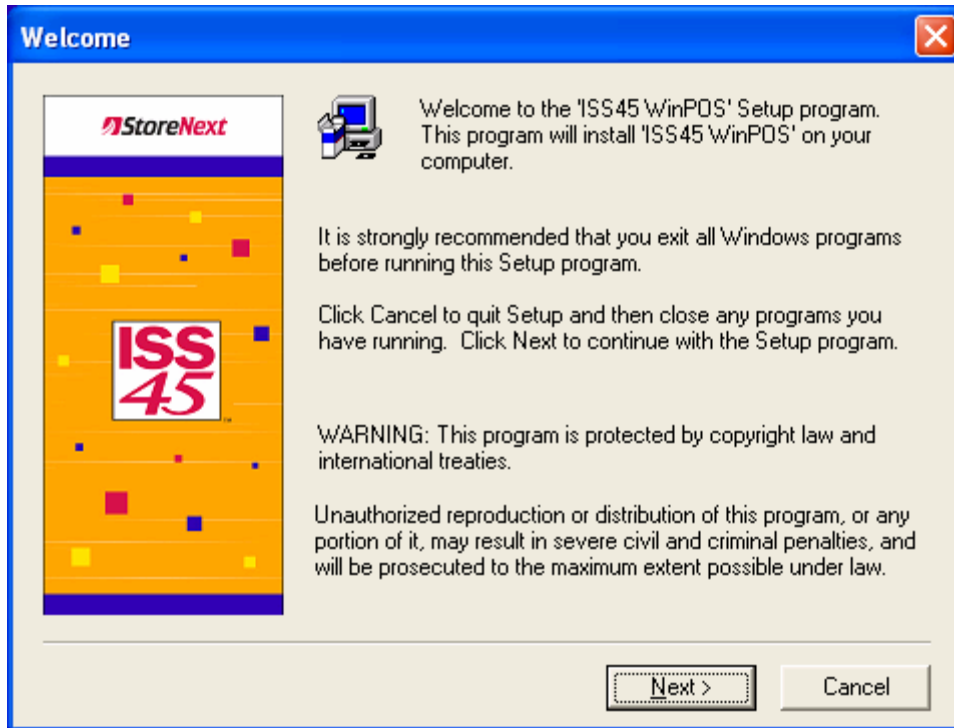

0.2.7. Click **Next** and the (User Information) screen is displayed



0.2.8. Change the information if so desired, click **Next** and the (Registration Confirmation) screen is displayed

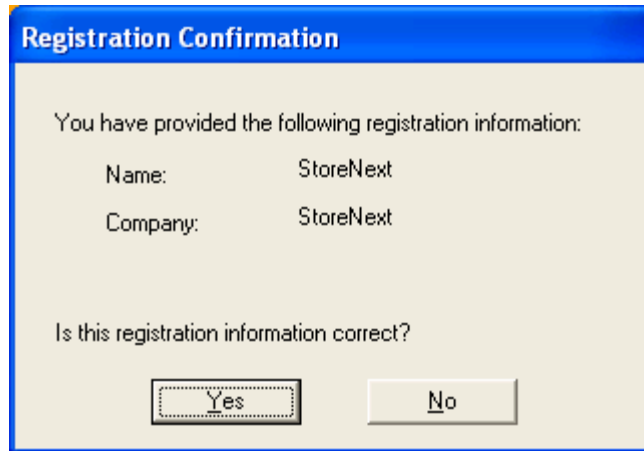

0.2.9. Click **Yes** and the (Choose Destination Location) screen is displayed

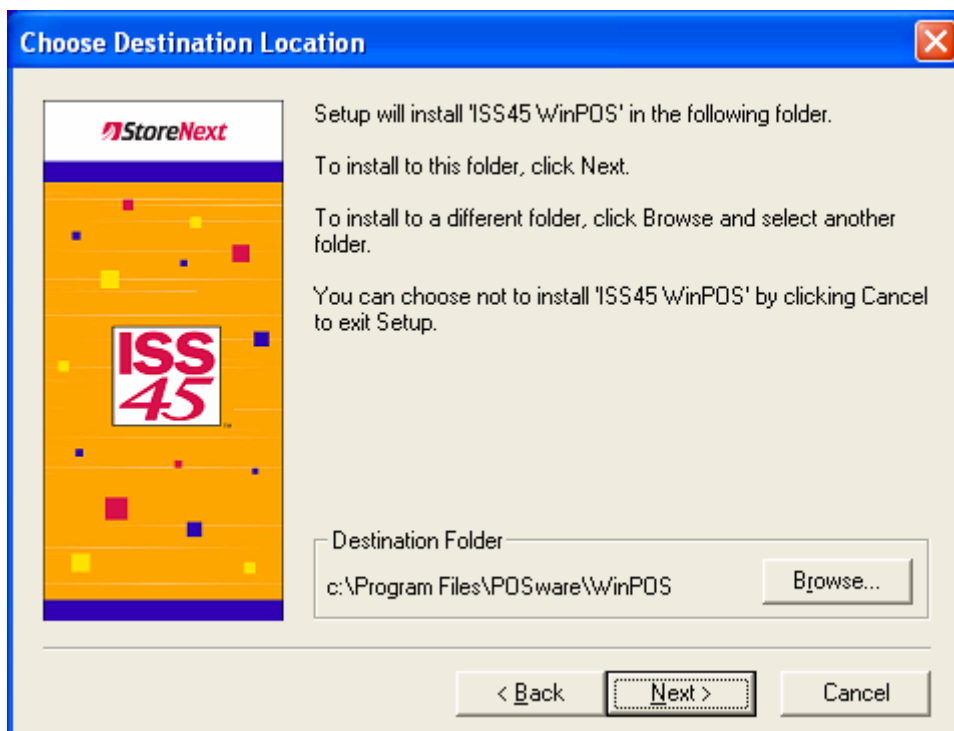

0.2.10. Click **Next** and the (Screen Resolution) screen is displayed

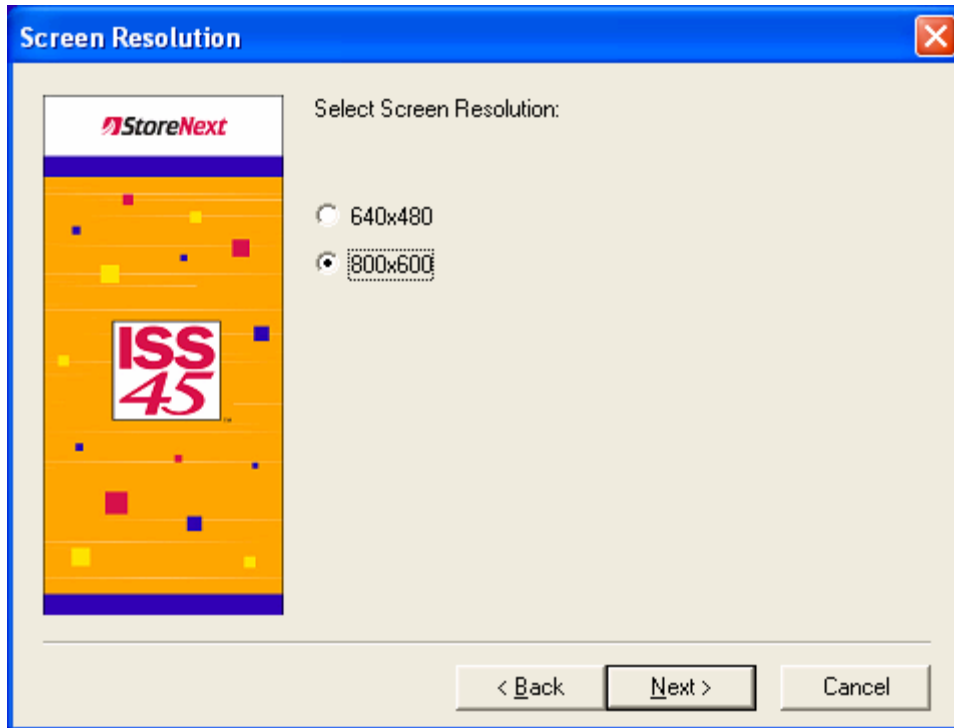

0.2.11. Ensure that 800x600 is selected, click **Next** and the (Screen Format) screen is displayed

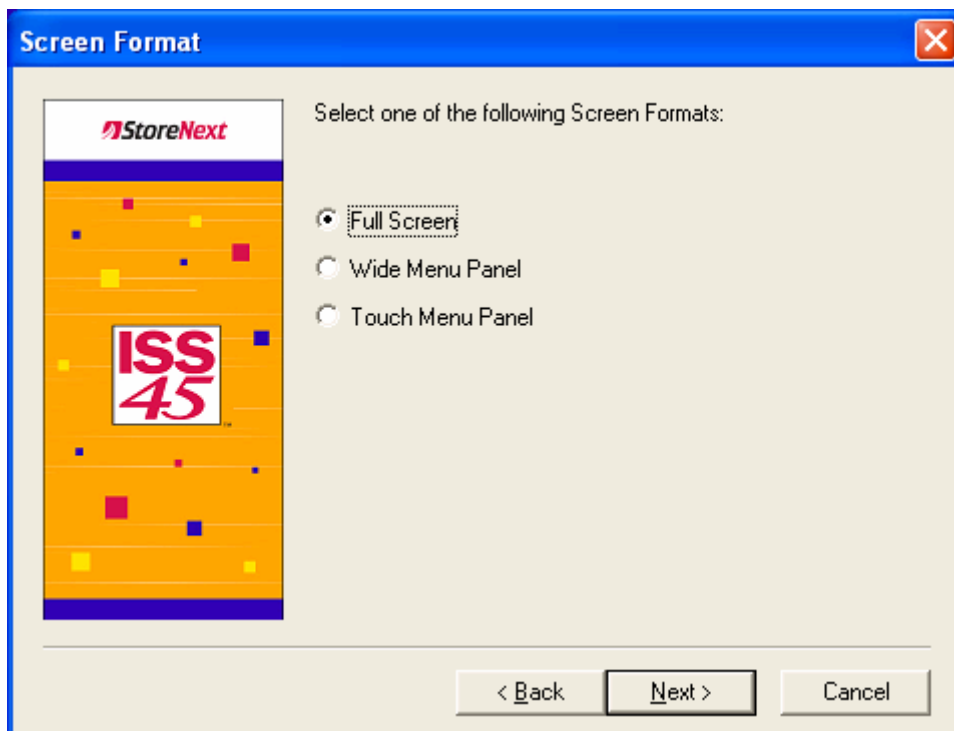

0.2.12. Select the configuration for your equipment setup

0.2.12.1. Full Screen does not provide any touch screen capabilities

0.2.12.2. Wide Menu Panel provides limited touch and requires some form of a keyboard

0.2.12.3. Touch Menu Panel provides full touch screen support and does not require any additional keyboards

0.2.13. Click **Next** and the (Color Configuration) screen is displayed

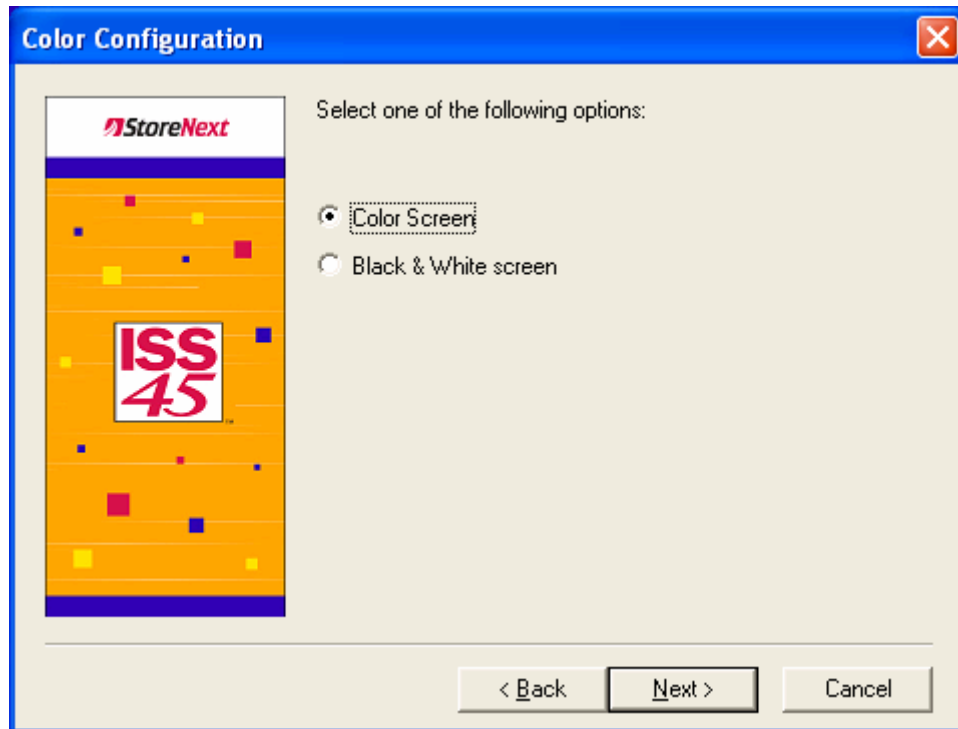

0.2.14. Ensure Color Screen is selected, click **Next** and the (VGA Configuration) screen is displayed

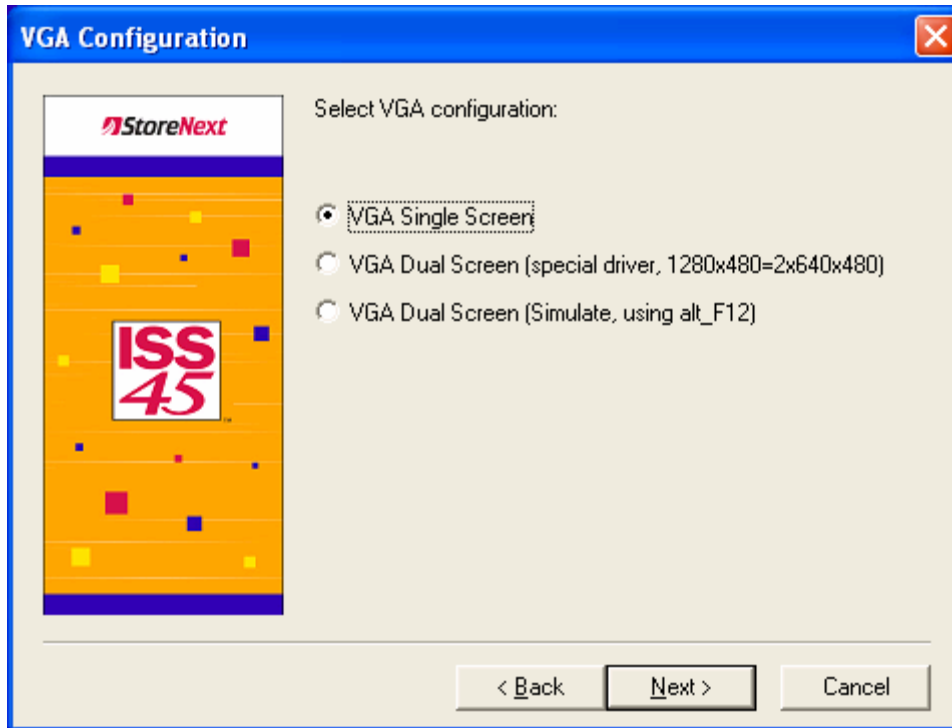

0.2.15. Ensure VGA Single Screen is selected for single displays, click **Next** and the (Hardware Type) screen is displayed

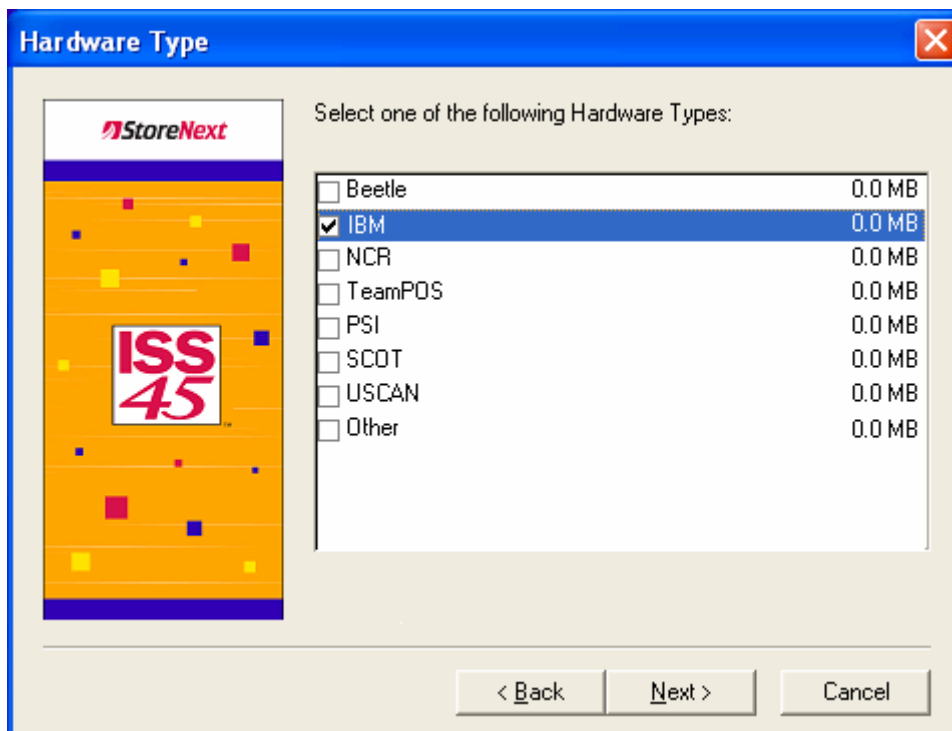

0.2.16. **NOTE: This step is critical and you need to ensure type IBM is selected,** click **Next** and the (POS Terminal Number) screen is displayed

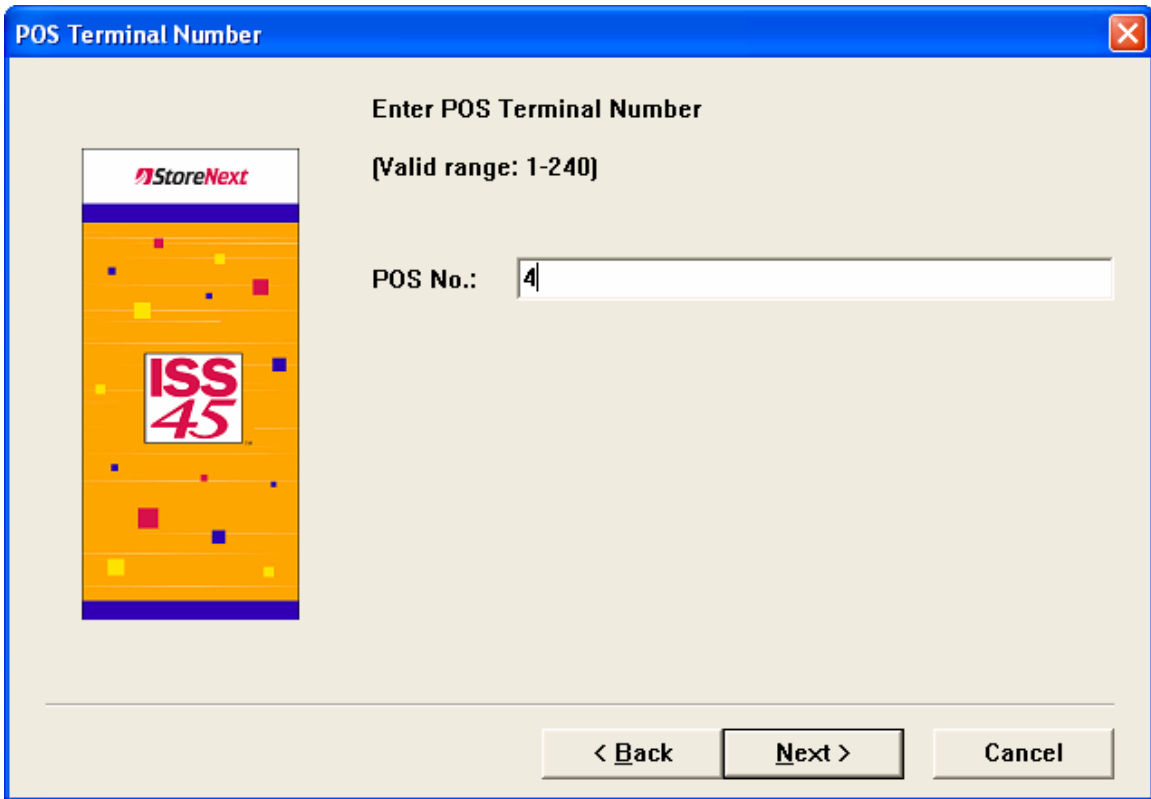

0.2.17. Enter the POS terminal number, click **Next** and the (Use Auto Logon?) screen is displayed

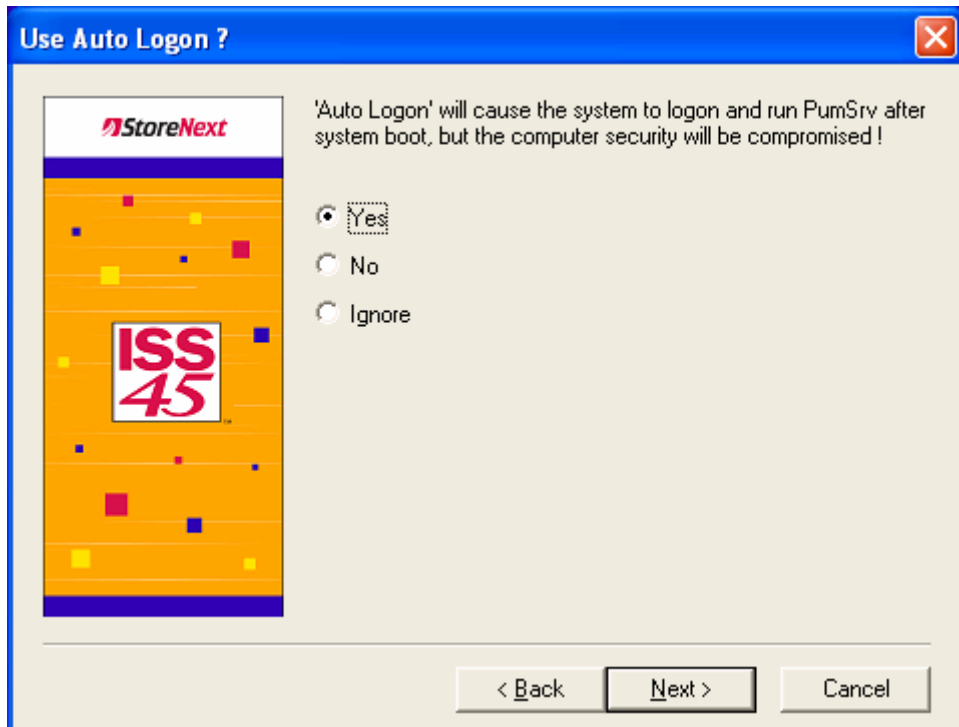

0.2.18. Ensure Yes is selected, click **Next** and the next (Use Auto Logon) screen is displayed

Use Auto Logon

Auto Logon will log on to NT automatically each time the terminal is switched on or rebooted.

User Name: Administrator

Password: *****

Confirm Password: *****

Enter the "User Password", must exactly match the value entered above (case sensitive).

< Back Next > Cancel

0.2.19. Fill in the Password and Confirm for your Administrator, click **Next** and the (Start Copying Files) screen is displayed

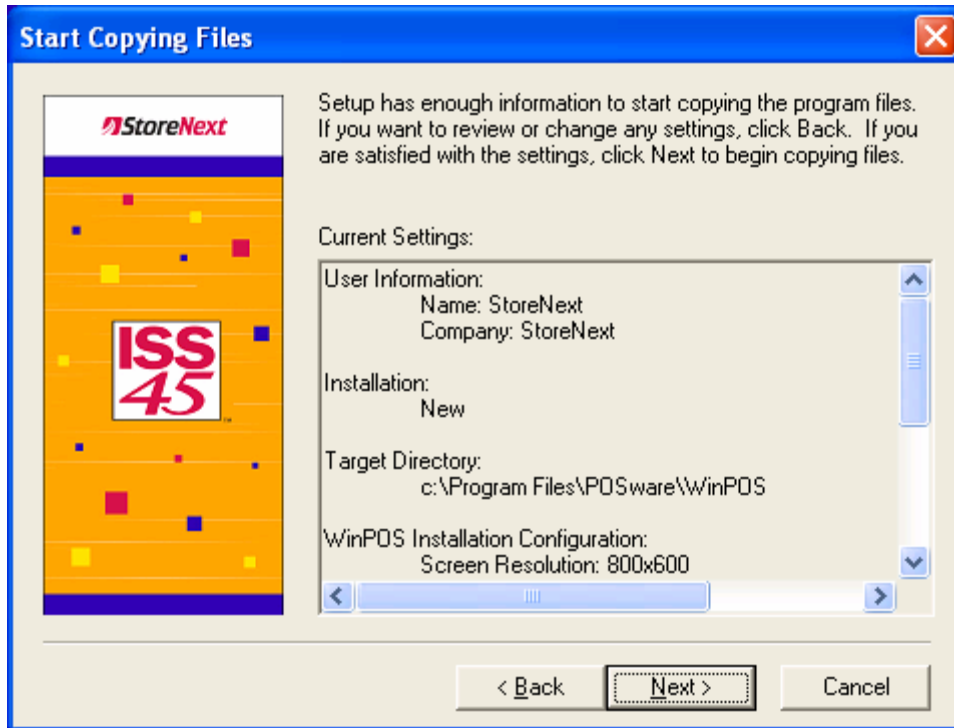

0.2.20. Review the information, click **Next** and the (HOSTS – Notepad) screen is displayed

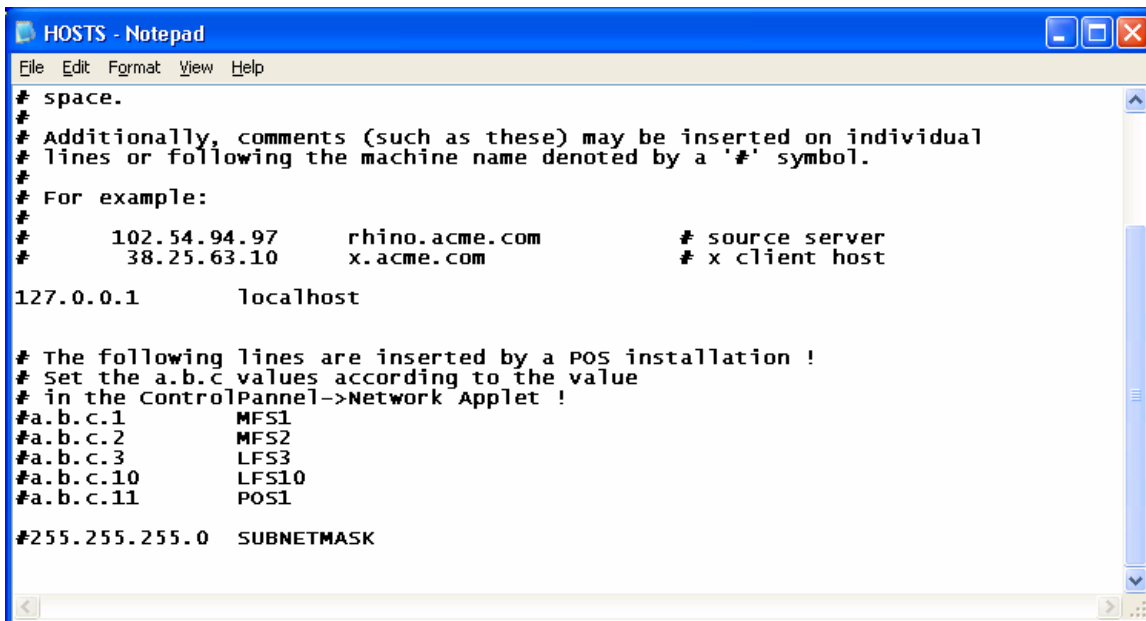

0.2.21. Make the necessary changes to the HOSTS file to match your network IP addressing and remove the # symbol on the items required for your store environment (example: see the following edited screen)

```
HOSTS - Notepad
File Edit Format View Help
# space.
#
# Additionally, comments (such as these) may be inserted on individual
# lines or following the machine name denoted by a '#' symbol.
#
# For example:
#
#      102.54.94.97      rhino.acme.com      # source server
#      38.25.63.10     x.acme.com          # x client host
127.0.0.1      localhost

# The following lines are inserted by a POS installation !
# Set the a.b.c values according to the value
# in the ControlPannel->Network Applet !
129.103.76.1   MFS1
129.103.76.2   MFS2
129.103.76.3   LFS3
129.103.76.10 LFS10
129.103.76.11 POS1
255.255.255.0 SUBNETMASK
```

0.2.22. Select File | Exit after making your changes and the following is displayed

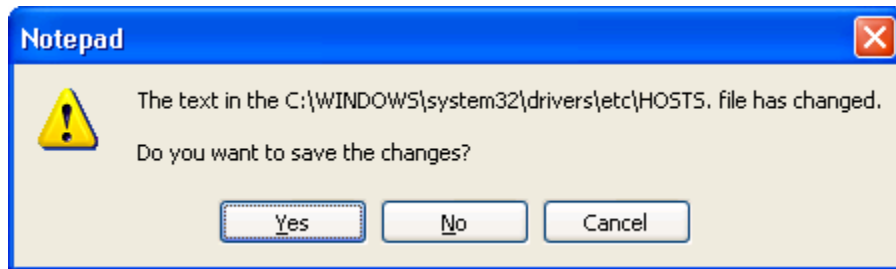

0.2.23. Click **Yes** and the installation continues until the (Setup Complete) screen is displayed

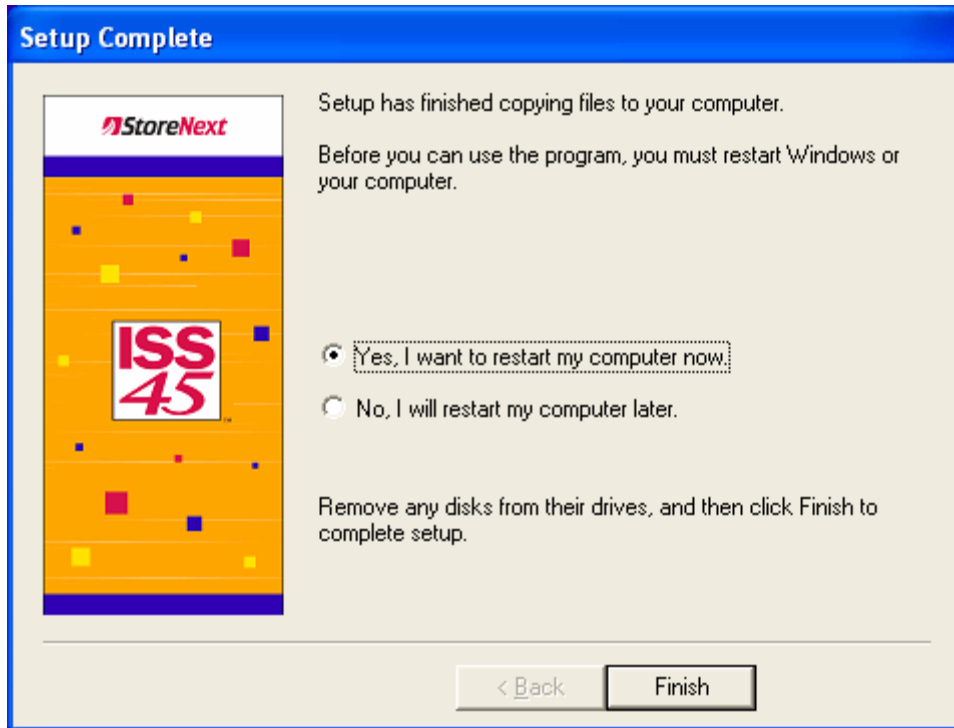

0.2.24. Ensure Yes is selected and click Finish

0.2.25. The computer will restart and start loading ISS45

0.2.26. Exit to the Windows Desktop when the ISS45 load has finished for further installation (example: adding payments, Xinetix, Catalina, applying patches)

ISS45 Peripheral Setup for Connected Devices

50-Key POS Keyboard

NOTE: MANUALLY COPY THE FILE KBDKMAP.DAT IN THE C:\PROGRAM FILES\POSWARE\WINPOS DIRECTORY TO THE C:\POSDLL FOLDER. REFER TO APPENDIX B FOR THE LAYOUT OUT OF THE KEYBOARD

ISS45 V7 Configuration

0.2.26.1. In ISS45 V7 POST Configuration 2 screen set the Port to 0

0.2.26.2. In the ISS45 V7 WinPOS.ini file, add the following two lines

NOTE: The following lines are case sensitive

OposKeyBoard=Yes

DefaultKeyBoardName=POSKybd

ISS45 V8 Configuration

0.2.26.3. In ISS45 V8 Post Configuration screen WinPOS H/W Tab set the Keyboard type to Standard, check Use OPOS and set the Port to 0

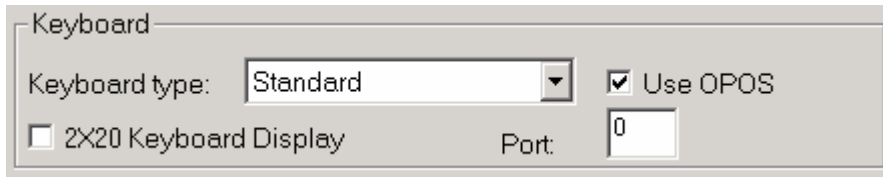

0.2.26.4. In ISS45 V8 Post Configuration screen E-Ticket – OPOS tab set the OPOS Keyboard Driver Name to POSKybd



2x20 External Customer Display

ISS45 V7 Configuration

0.2.26.5. In ISS45 V7 POST Configuration 1 screen leave COM 0, IRQ 0, Type None and Baud rate None



0.2.26.6. In the ISS45 V7 WinPOS.ini file, add the following two lines

NOTE: The following lines are case sensitive

OposLineDisplay=Yes

DefaultLineDisplayName=LineDisplay

ISS45 V8 Configuration

0.2.26.7. In ISS45 V8 Post Configuration screen WinPOS H/W Tab set Customer Display Type None, Baud Rate None, Port 0 and check Use OPOS

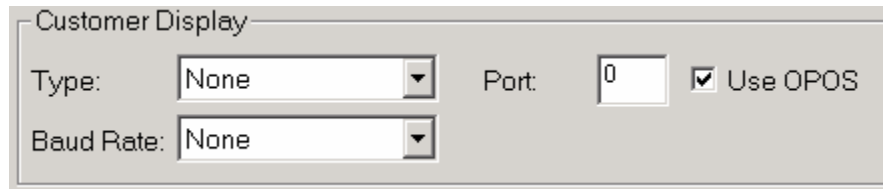

0.2.26.8. In ISS45 V8 Post Configuration screen E-Ticket - OPOS tab set the OPOS Line Display Driver Name to LineDisplay



IBM 4610-DG4 printer

ISS45 V7 Configuration

0.2.26.9. In ISS45 V7 POST Configuration 1 screen set Printer type OPOS Generic, Port None, MICR reader in use checked, OPOS checked



0.2.26.10. In the ISS45 V7 WinPOS.ini file, add the following lines

NOTE: The following lines are case sensitive

DefaultPrinterName=POSPrinter

OposMicr=Yes

DefaultMicrName=POSMICR

ISS45 V8 Configuration

0.2.26.11. In ISS45 V8 Post Configuration screen WinPOS H/W Tab set Printer Type OPOS Generic, Baud Rate: None, Port 0, check Use OPOS and check MICR

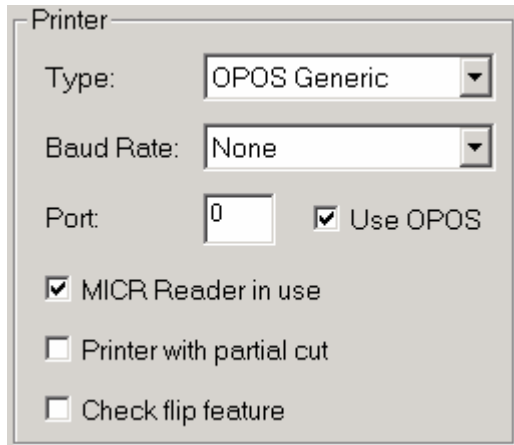

0.2.26.12. In ISS45 V8 Post Configuration screen E-Ticket - OPOS tab set the OPOS Printer Driver Name to POSPrinter



0.2.26.13. In ISS45 V8 Post Configuration screen E-Ticket – OPOS tab set the OPOS MICR Driver Name to POSMICR and check Use OPOS MICR



PSC 8200 or 8500 USB Scanner and Scale configuration

Note: refer to the ISS45 software CD \PSC folder for the RS232 setup

ISS45 V7 Configuration

0.2.26.14. In ISS45 V7 POST Configuration 1 screen set Scanner COM 0, IRQ 0, Baud Rate None, Data Bits 0, Parity None and Handshake unchecked

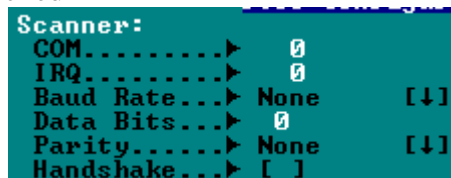

0.2.26.15. In ISS45 V7 POST Configuration 1 screen set Scale Type None, COM None, IRQ 0 and Baud Rate None

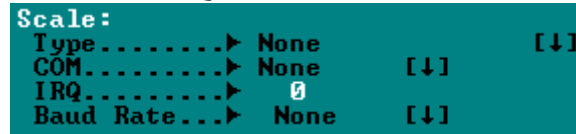

0.2.26.16. In the ISS45 V7 WinPOS.ini file, add the following lines

NOTE: The following lines are case sensitive

OposScanner=Yes

DefaultScannerName=TableScanner

OposScale=Yes

DefaultScaleName=TableScale

ISS45 V8 Configuration

0.2.26.17. In ISS45 V8 Post Configuration screen WinPOS H/W Tab set Scanner1 Port 0, check Use OPOS, Baud Rate None, Parity None and Data bits blank

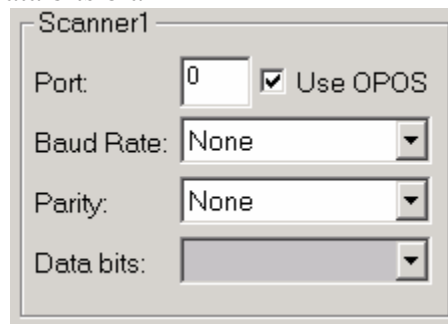

0.2.26.18. In ISS45 V8 Post Configuration screen E-Ticket – OPOS tab set OPOS Scanner Driver Name to TableScanner



0.2.26.19. In ISS45 V8 Post Configuration screen WinPOS H/W Tab set Scale Port blank, check Use OPOS, Type blank, Baud Rate blank, Data bits blank, Parity blank and check Display constant weight

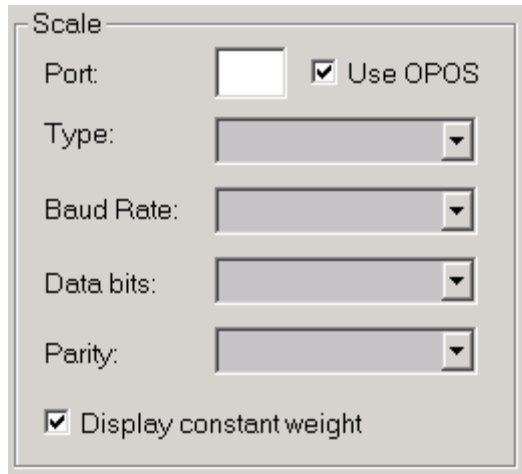

0.2.26.20. In ISS45 V8 Post Configuration screen E-Ticket – OPOS tab set OPOS Scale Driver Name to TableScale

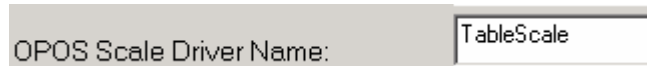

Cash Drawer

ISS45 V7 Configuration

0.2.26.21. In ISS45 V7 POST Configuration 1 screen check Drawer in use

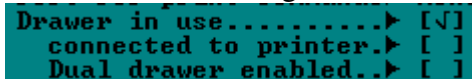

0.2.26.22. In the ISS45 V7 WinPOS.ini file, add the following two lines

NOTE: The following lines are case sensitive

OposDrawer=Yes

DefaultDrawerName=CDrawer

ISS45 V8 Configuration

0.2.26.23. In ISS45 V8 Post Configuration screen WinPOS H/W Tab set

Drawer Type Basic and check Use OPOS

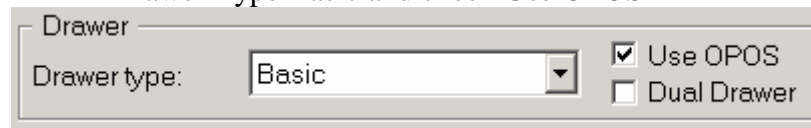

0.2.26.24. In ISS45 V8 Post Configuration screen E-Ticket - OPOS tab set the OPOS Drawer Driver Name to CDrawer

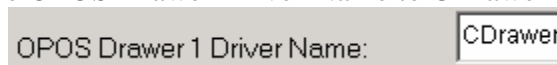

MSR and Key Lock

Note: The Keyboard MSR is not supported on ISS45 because of the encryption requirement not met in the ISS45 software. Use a payment pin pad only with Microtrax WinEPS

ISS45 V7 Configuration

0.2.26.25. In the ISS45 V7 WinPOS.ini file, add the following lines

NOTE: The following lines are case sensitive

OposKeyLock=Yes

DefaultKeyLockName=POSKeylock

ISS45 V8 Configuration

0.2.26.26. In ISS45 V8 Post Configuration screen E Ticket – OPOS tab set OPOS KeyLock Driver Name to POSKeylock and check Use OPOS KeyLock



HyperCom 4100/4150/4250 USB Pin Pad

NOTE: This setup is only for setting up the HyperCom 4100/4250 when using the USB connection. The RS232 setup is the same as before.

ISS45 V7 Configuration

0.2.26.27. In ISS45 V7 POST Configuration 1 screen, click on the Auth/APT button to bring up the POST Auth/APT Configuration screen.

0.2.26.28. Authorization Type is EFT, COM needs to be a number in the range of 1-4 to activate the USB Pin Pad. A blank or 0 value will not work. Use 2 if you are unsure.

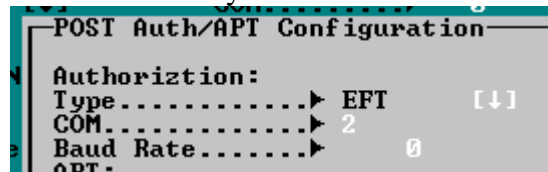

ISS45 V8 Configuration

0.2.26.29. In ISS45 V8 Post Configuration screen, click on the Auth – EFT – If tab at the top.

0.2.26.30. Authorization Type is EFT, COM needs to be a number in the range of Com1 – Com4 to activate the USB Pin Pad. None on the drop down with not work.

Authorization

Type: EFT

Port: Com1

Baud Rate: 9600

Further installation

0.3. Scope of this document

- 0.3.1. This document is not intended to cover past this point of the installation of the SurePOS
- 0.3.2. Installation of Payment systems, etc., are handled exactly the same as they are on any other machine
- 0.3.3. As a final reminder, you need to apply one of the patches (cc, mtx, or us) to the ISS45 software load for configuration or updates

Appendix A: Product Images.



Figure 33: SurePOS 500 System



Figure 34: 50-Key Keyboard



Figure 35: IBM 4610-DG4 Printer



Figure 36: IBM 2x20 Customer Display



Figure 37: IBM Cash Drawer



Figure 38: IBM 4820-5GN Touch Flat Panel

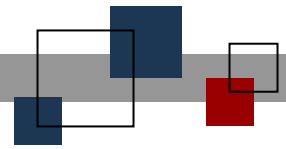

© StoreNext Retail Technologies LLC 2008

StoreNext Retail Technologies LLC endeavors to ensure that the information in this document is correct and fairly stated but does not accept liability for any error or omission.

The development of StoreNext products and services is continuous and published information may not be up to date. It is important to check the current position with StoreNext. This document is not part of a contract or license save insofar as may be expressly agreed.