

TeamPad 7500

Operations *Guide*



ICL Handheld Systems
Providing Lightweight,
Rugged Solutions for
Mobile Environments

ICL
Handheld Systems
11085 N. Torrey Pines Rd.
La Jolla, CA 92037
Tel: 1-800-228-8683
Fax: 858-457-2701
handheldproducts@iclhandheld.com
www.iclhandheld.com

Millennium House
Thames Valley Park Drive
Reading, RG6 1RB, UK
Tel: +44 (0) 118 938 3000
Fax: +44 (0) 118 938 3020
rproducts@iclretail.com

90000079
Version 2.0

Version 2.0 February 2000

Copyright © Fujitsu Limited and Fujitsu-ICL Systems, Inc. All Rights Reserved

TeamPad is a trademark of Fujitsu Ltd. MS-DOS, Windows NT and Microsoft are registered trademarks of Microsoft Corporation. Additionally, the company names and product names described in this manual are the trademarks of those respective companies.

The contents of this manual may be revised without prior notice. Specifications are subject to change without notice.

Revision Record

Edition	Date Issued	Description of Change	Page (s)
V. 2.0	February 2000	Initial Release	All

FCC WARNING

Changes of modifications not expressly approved by the party responsible for compliance could void the user's authority to operate the equipment.

This equipment has been tested and found to comply with the limits for a Class A digital device, pursuant to Part 15 of the FCC Rules. These limits are designed to provide reasonable protection against harmful interference when the equipment is operated in a commercial environment. This equipment generates, uses, and can radiate radio frequency energy and, if not installed and used in accordance with the instruction manual, may cause harmful interference to radio communications. Operation of this equipment in a residential area is likely to cause harmful interference in which case the user will be required to correct the interference at his own expense.

To Use This Product Safely

This manual contains important information required for the safe use of this product. Read this manual thoroughly, paying particular attention to the “Notes on Safety,” before attempting to operate this device. It is strongly advised that the user keep this manual in a safe and convenient location so that it can be referenced should any questions or problems arise.

FUJITSU makes every effort to prevent users and observers from being injured and to prevent property from suffering damage. To ensure no harm to you, observers, or the equipment itself, be sure to use the product according to the instructions in this manual.

Preface

Thank you very much for purchasing our TeamPad7500 (PBT7500).

Carefully read this manual for the proper procedures to correctly use this device. This manual also provides instructions on how to make the best use of all the available functions.

Microsoft and Windows NT are the registered trademarks of Microsoft Corporation in USA and other countries.

Additionally, the company names and product names described in this manual are the trademarks of companies.

TeamPad 7500 Models and Features

The TeamPad 7500 Series includes one model:

- PBT7500-16: TeamPad 7500 Thin Client Handheld with Windows CE WBT preloaded, MMCX antenna, integrated 10 Key keypad

The TeamPad 7500 Charger Stand

- PBT7531-01: Charger Stand, with AC adapter and power cord (US version)
- PBT7531-11: Charger Stand with Daisy Chain cable

The TeamPad 7500 Dual Battery Pack Charger

- PBT7531-03: Dual Battery Pack Charger, with power cord (US version)
- PBT7531-05: 1750 mAh Battery Pack (Spare)

TeamPad 7500 Server Software

- PBT7561-10: Com LAN Transporter (allows bar code scanning operations) 10 user license

Alert Messages

This manual uses the following alert messages. An alert message consists of an alert signal and a message. An alert signal consists of a symbol and a word or just a word.

The following are the alert signals and their meanings:



Indicates a hazardous situation.

A personal injury could result if the user does not perform the correct procedures.



Indicates a hazardous situation.

A minor or moderate personal injury could result if the user does not perform the correct procedures. Also, caution indicates that damage to the product or other property may occur if the user does not perform the correct procedures.

Alert Symbols

This manual uses easy to identify alert symbols. The aim is to help users identify warnings at first glance. The alert symbols are shown below with notes on safety.

The following are the alert symbols and their meanings:



Electrical
shock

Indicates that improper usage may cause an electrical shock.



Prohibited

Indicates prohibited action.



Caution

Indicates caution required.

Notes on Safety

- Handling this device

WARNING



Electrical shock

Observe the following to avoid an electrical shock or fire:

Do not damage the power cord of any of the chargers in use (e.g., the charger of the main equipment).

Do not use an outlet with a loose insertion port.

Do not connect or disconnect the charger when your hands are wet.

Do not connect an excess number of power cords to a single outlet.



Prohibited

Use only the designated chargers and expansion stations. Otherwise, an unapproved rating of voltage or current may damage the device.

Do not disassemble or alter the device. Doing so may cause a device failure, electrical shock, fire, or other defects.

To avoid a device failure, do not leave the device in the following places for even a short period of time:

- 1 A place where the temperature may sharply rise (e.g., in a car with the windows closed on a sunny day)
- 2 A place where the device may be exposed to direct sunlight
- 3 A place where the temperature is too hot or cold
- 4 A dusty or dirty place
- 5 A place where the device may vibrate
- 6 A wet or humid place

Do not insert anything metallic or flammable into the openings of the device (e.g., slots). Doing so may cause a device failure, electrical shock, fire, or other such defects.

Always keep the power supply of the charger and the insertion port of the outlet clean. If they are dusty, clean with a dry cloth. Failure to keep the charger and the outlet clean may cause a fire.

Do not use the device when electrical storms (especially storms accompanied by thunder and lightning) occur in the vicinity. In such a case, turn off the power to the device immediately and disconnect the charger from the outlet. Lightning will cause damage to the device, and a fire may also result.

If any heat, smoke, odor, or any abnormal sound emits from the device, immediately turn the power off. Then disconnect the charger and remove the battery.

Using the device when any of these conditions occur, may cause an electrical shock or fire.

 **CAUTION**



Caution

The handheld device is precision equipment containing an LCD(liquid crystal display).

Do not apply strong force, shock, or drop the device. Doing so may damage or destroy the LCD.

When not planning to use the device for a long time, disconnect the charger. Disconnect the charger from the outlet and the device. Failure to do so may cause an electrical shock or fire.

Completely charge the battery before disconnecting it from the outlet.

Use only the charger specified in the manual.

Do not disassemble or alter the charger. Doing so may cause a device failure, fire, or injury.

Do not cover or wrap the device and charger with a cloth when in use. Doing so raises the internal temperature which may result in a fire.

- Battery pack (Lithium-ion battery pack)

 **WARNING**

Use only the designated charger to charge the battery pack.

Do not connect the positive and negative terminals of the battery pack to anything metallic (e.g., a chain necklace).

Do not heat the battery pack or dispose of it by throwing it into a fire.

Do not leave the battery pack in a hot place (e.g., in a car on a sunny day or outside on a scorching day).

Do not moisten or wet the battery pack with any fluid.

Do not apply any strong force, shock, or drop the battery pack.

Do not disassemble or alter the battery pack.

If any liquid leaks from the battery pack, clean the case. Then mount a new battery pack.

A fully charged battery pack loses power and deteriorates when stored for a long time. Charge the battery to about 50% capacity when storing for a long time.

The LED of the battery pack on the front of the device flashes red when the battery pack needs to be charged. When the LED starts flashing, immediately turn the power off. Then replace the battery pack with a fully charged battery. Alternatively, charge the weak battery. See Section 1.3.2 “Battery charging.”

If the battery pack is not correctly mounted or defective at the charging, the LED flashes in red. Correctly mount or replace the battery pack.

The capacity of the battery pack decreases over time. The time which the battery can be used shortens as its capacity decreases. When the capacity of the battery has decreased to the point where there is a significant reduction in service time despite normal charging, the battery is reaching the end of its service life. Replace the battery pack in this case. A battery pack lasts for about 500 charges. The service life of the battery pack varies depending on the ambient temperature and the operating environment of the device. If the battery pack is not used at room temperature (between 10° to 30°C), it may reach the end of its service life before being charged 500 times.

The battery pack can be charged before the LED of the battery pack starts flashing in red. The battery pack can also be removed from the charger before charging is complete.

A battery pack which has been stored for a long period of time needs to be charged before it is used.

Dispose of any used batteries, according to the instructions of the Fujitsu service personnel.



- Usage in a cold region

Low temperature (10°C or lower) degrades the performance of a battery. The life of the battery in a cold region may be shorter than the average.

Follow the instructions listed below to efficiently use the battery:

- 1 When the LED of the battery flashes red, charge or replace the battery pack with a spare.
- 2 Warm the spare by keeping it in your pocket until ready to mount. When warming the spare with a body heater, be careful not to directly contact the heater to the battery.
- 3 The battery pack should be charged at room temperature (between 10° to 30°C).

- Efficient battery usage

- 1 Be careful not to allow any debris (such as sand or dust) into the terminals of the battery. If the terminals get dirty, clean them with a soft cloth. Then connect the battery to the charger or mount the battery in the device.
- 2 Even after being fully charged, the battery naturally will gradually lose power as time passes. Recharge the battery one or two days before use.
- 3 Store the battery pack in a cool place. To ensure long life, charge the battery pack at room temperature (between 10° to 30°C).

- Notes on long storage

Store the device in a place free from the following: vibration, dust, extremely high or low temperature, high humidity, and direct sunlight.

- Cleaning

- 1 Covers

Clean the covers with one of the following: a dry cloth; or a damp cloth, a cloth soaked in a diluted mild detergent and firmly squeezed. When using a cloth soaked in a soap-water solution, squeeze the cloth firmly enough to prevent any water from dripping into the device. Water may cause a device failure.

Do not use volatile solvents such as thinner and benzene. They cause discoloration and may erase the characters on the covers.

- 2 Display

Clean the display with one of the following:

-- a cloth soaked in water and firmly squeezed

-- a fine cloth, such as those used for cleaning eyeglasses

Notation

Marks used in this manual

Mark	Meaning
NOTE	Must be observed by the user as well as requests for the user. The user must read every NOTE .
📖 Advice 📖	References that must be observed by the user.
> > Reference > >	This indicates a reference.
➤	This indicates the result in response to the operation.

Terms used in this manual

Term	Meaning
Server	This indicates a terminal server to be connected to this unit.
Tap	This means that a screen should be pressed on this unit once.
Double tap	This means that a screen should be pressed on this unit twice, in rapid succession.

Preface

<u>Notation</u>	x
Marks used in this manual.....	x
Terms used in this manual.....	x

Preface xi

1 Introduction to the TeamPad 7500	1
1.1 Overview of This Unit	1
1.2 Component Names.....	2
1.3 Battery Usage.....	6
1.3.1 Battery details.....	6
1.3.2 Battery charging.....	7
1.3.3 Setting/Removing the battery.....	14
Setting the battery.....	14
2 TeamPad 7500 Setup.....	15
2.1 Setting the Network	15
2.2 Setting to connect the Server.....	18
2.3 Enter the Settings for the Terminal Server/Power Saving.....	22
3 Using This Unit	25
3.1 Turning on/off the Power Supply	25
3.1.1 Turning on the power supply	25
3.1.2 Turning off the power supply	26
3.2 Controlling the Speaker's Volume.....	27
3.3 Confirming the Battery Status.....	28
3.4 Controlling the Back Light of the Screen.....	30
3.5 Controlling the Contrast of the Screen.....	30

3.6	Calibration of the Touch Panel	31
3.7	Adjusting the TeamPad 7500 Setup Settings.....	34
3.7.1	Changing the setup settings	34
3.7.2	Initializing the setup settings.....	34
3.8	Using the Screen Keyboard	36
3.8.1	Entering the characters	36
3.8.2	Changing the mode.....	36
4	LED Display.....	36
4.1	LED Displayed While in Operation	36
4.2	LED Displayed When the Power Supply Is On	37
4.3	LED Displayed While Charging Is Performed.....	37
4.3.1	LED of this unit during charging.....	37
4.3.2	LED of the dual battery pack charger during charging.....	38
5	SS Radio	39
6	If A Message Is Displayed... ..	40
7	Troubleshooting	42
A	TeamPad 7500 Specifications	43
B	Expendable Supplies.....	44
C	Accessories	45
D	Optional Equipment.....	46
Index	47

1 Introduction to the TeamPad 7500

1.1 Overview of This Unit

The TeamPad 7500 is connected to a server (OS: Microsoft® Windows NT® Server 4.0 Terminal Server Edition) through an SS radio LAN and is operated after securing the connection.

This unit uses the application software on the server through an SS radio.

The settings of the LAN and the SS radio are required for this unit to be connected to the server when setting up this unit.

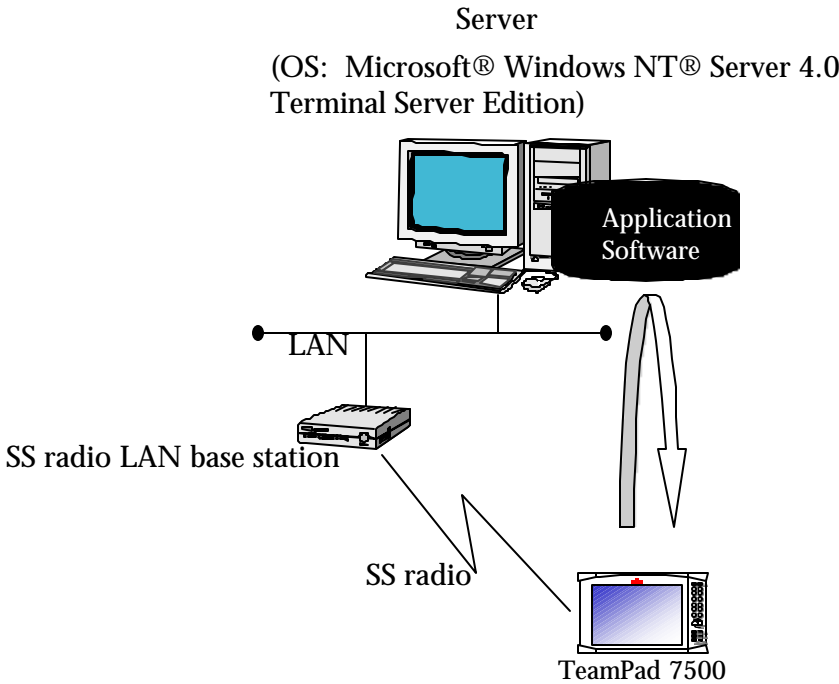

1.2 Component Names

[Front]



No.	Component name	Remarks
1	Radio antenna	Built-in
2	Battery case	The case that holds the battery.
3	Speaker	Built-in
4	LCD touch panel	Hereafter called “touch panel” or

[Bottom]



No.	Component name	Remarks
1	AC adapter connector	Connector for the AC adapter
2	Charging terminal	Terminal connected to the charging adapter

[Back]

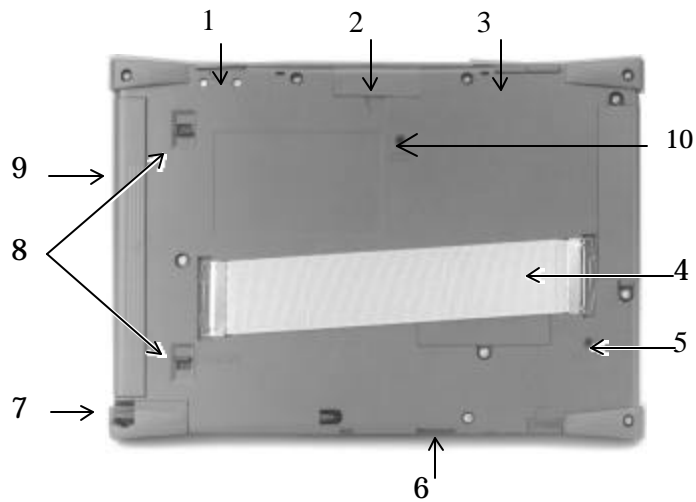

No.	Component name	Remarks
1	Bar code reader interface	Will be supported.
2	Extended interface	Will be supported.
3	Audio interface	Will be supported.
4	Hand strap	Attached to product
5	Reset switch	Switch for restarting this unit
6	IrDA interface	Will be supported.
7	Pen	Touch panel pen
8	Battery lock switch	Switch for locking the battery
9	Battery	—
10	RAS switch	For Maintenance purposes only

 Prohibited

- The RAS switch should not be pushed, because the 7500 may change out of normal operation mode.

[Keys]

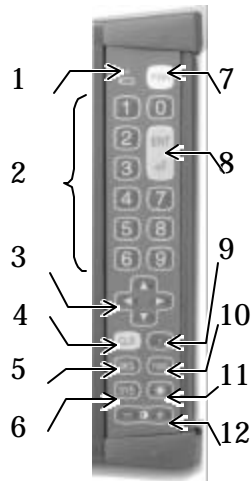

No.	Component name	Remarks
1	Power/Charging status LED	LED for displaying the power supply and charging status. Hereafter called "LED".
2	Ten key	—
3	Cursor key	—
4	Clear key	—
5	Backspace key	—
6	System key	Hereafter called the [SYS] key.
7	Power key	For turning on/off the power supply. Hereafter called the [PWR] key.
8	Enter key	Hereafter called the [ENT] key.
9	Decimal Point key	—
10	Function key	Hereafter called the [FUNC] key.
11	Back light key	For controlling the brightness of the back light on the screen. Hereafter called the [☼] key.
12	Contrast key	For controlling the contrast of the screen. Hereafter called the [+] key or the [-] key.

The keyboard layout was designed with the intention that this unit can be held in a variety of comfortable ways and with the keyboard operating with the thumb of the user's right hand. The following figures demonstrate comfortable ways of holding and operating the 7500.



1

No.	Component name	Remarks
1	Neck strap	Option

1.3 Battery Usage

1.3.1 Battery details

- Battery type

The TeamPad 7500 has a 1750 mAh lithium ion battery.

A battery has multiple terminals.

- Battery Life

Charging and discharging a battery can be repeated approximately 500 times.

The duration of battery life becomes shortened as it is used repeatedly. The battery should be replaced with a new one when the output the battery yields after a full charge becomes low. The battery's life depends on usage conditions such as ambient temperature and storage conditions.

- Charging Status LED

The battery voltage may be below the specified voltage (6.6 V) when the LED flashes red at an interval of approximately 3 seconds. In this case, the battery should be charged, or replaced with a spare one.

However, the LED does not flash red even if the battery voltage is below the specified voltage (6.6 V) when the AC adapter is connected.

- Charging Request Message

It can be set whether or not the message to request charging period is displayed.

>>Reference>> “2.2 Setting to connect the Server”

- Battery status

The battery status, residual battery capacity, residual expected available time, and charging/discharging count can be confirmed.

>>Reference>> “3.3 Confirming the Battery Status”

- Trouble information LED

A battery with a low amount of charge left is indicated when the LED flashes green at an interval of about 0.5 seconds. Replace the battery with a fully charged one.

When the LED flashes red for 5 seconds at an interval of 0.5 seconds between series, this indicates a possible hardware fault with the 7500. Contact a Field support service representative immediately.

1.3.2 Battery charging

The battery should be charged when a new battery is used, or when the residual battery capacity is low.

The battery can be charged by using any of the following three methods:

- Charging with the Charge Stand (PBT7531-01)
- Direct charging the handheld with AC adapter (PBT7631-11)
- Charging with the Battery Pack Charger (PBT7531-03)

CAUTION

- The plug of the AC adapter or battery pack charger should not be pulled out of the plug socket until charging has been completed.
- The special charging adapter, AC adapter, and battery pack charger must be used, otherwise this unit may be damaged due to the difference in voltage or current capacity.

NOTE

- This unit must be turned off before charging when the charging adapter or AC adapter is used.
- The optimum room temperature is 10°C to 30°C for charging activities.

Charge with the Charger Stand

There are two methods of charging a TeamPad 7500 with a charger stand. The first is to charge one handheld with one charger stand, and the other is to charge two units simultaneously with two charger stands. To charge a TeamPad 7500 with a charger stand, follow the steps below. Approximately 2.5 hours of charge time is required to fully charge the handheld using a charger stand.

Charging one unit with one charger stand

This picture shows a 7500 sitting correctly in its charger stand. The charger stand and AC adapter (PBT7531-02) are required for using this method.



- (1) Turn this unit off.
- (2) Connect the AC adapter to the AC adapter connection interface of the charging adapter.
- (3) Verify the voltage levels correspond between the AC Adapter and your AC outlet. Insert the plug of the AC adapter into the AC outlet.

(4) Set this unit with the battery upright on the charging adapter.

- Charging will automatically begin.

The LED turns green while the unit is being charged. The LED turns off when charging has completed. Charging time is approximately 2.5 hours.

NOTE

- This unit must not be subjected to shock when setting this unit upright in the charging stand. Problems may occur with the unit or to the charging stand if the unit is subjected to shock.
- When the LED flashes green at an interval of approximately 0.5 seconds, it indicates that charging is not happening correctly. In this case, the battery voltage may be below the specified voltage, or even the charged voltage may not reach the specified value, or the battery may simply be damaged.

The battery should be replaced with a new one. The LED turns off when the plug of the AC adapter is pulled out of AC inlet.

- Charging cannot be performed when the LED flashes red, because the AC adapter voltage is below the specified voltage

The AC adapter may have a problem, therefore contact a field support service representative. The LED turns off when the plug of the AC adapter is pulled out of the AC inlet.

Charging with two charge stands

The following steps describe charging two handhelds with two charger stands. An AC adapter and charger stand connector cable are required for using this method. PBT7531-11 contains a charge stand and the daisy chain cable. The picture below shows a single 7500 sitting correctly in a charger stand which has been linked together with a second charger stand via the charger stand connector cable.



- (1) Turn the 7500 off.
- (2) Connect the plug sockets of the AC adapter connection interfaces of two charger stands to each other with the charger stand connector cable.
NOTE: The charger stand has two AC adapter plug sockets, but either plug may be used to connect with the charger stand connector cable.
- (3) Connect the AC adapter to a non-utilized plug connector in any of the two charger stands.
- (4) Verify the voltage levels match between the AC adapter and the power outlet. Insert the plug of the AC adapter into AC power outlet.
- (5) Set this unit upright with the battery held in the charging adapter.
 - Charging will automatically begin.
The LED turns green while the unit is being charged. The LED turns off when charging has completed. Charging time is approximately 2.5 hours.

NOTE

- This unit must not be subjected to shock when setting this unit upright in the charging stand. Problems may occur with the unit or to the charging stand if the unit is subjected to shock.
- When the LED flashes green at an interval of approximately 0.5 seconds, it indicates that charging is not happening correctly. In this case, the battery voltage may be below the specified voltage, or even the charged voltage may not reach the specified value, or the battery may simply be damaged.

The battery should be replaced with a new one. The LED turns off when the plug of the AC adapter is pulled out of AC inlet.

- Charging cannot be performed when the LED flashes red, because the AC adapter voltage is below the specified voltage

The AC adapter may have a problem, therefore contact a field support service representative. The LED turns off when the plug of the AC adapter is pulled out of the AC inlet.

Charge with the AC adapter

The method described below is to connect the AC adapter to the 7500 and charge the unit, while the battery remains in the unit. The AC adapter is required for using this method. The picture below illustrates this.



- (1) Turn the handheld off.
- (2) Connect the AC adapter to the 7500 using the ac adapter port.
- (3) Verify the voltage levels of the AC adapter match the AC outlet. Insert the plug of the AC adapter into the AC outlet.

- Charging will automatically begin.

The LED turns green while the unit is being charged. The LED turns off when charging has completed. Charging time is approximately 2.5 hours.

NOTE

- When the LED flashes green at an interval of approximately 0.5 seconds, it indicates that charging is not happening correctly. In this case, the battery voltage may be below the specified voltage, or even the charged voltage may not reach the specified value, or the battery may simply be damaged.

The battery should be replaced with a new one. The LED turns off when the plug of the AC adapter is pulled out of AC inlet.

- Charging cannot be performed when the LED flashes red, because the AC adapter voltage is below the specified voltage

The AC adapter may have a problem, therefore contact a field support service representative. The LED turns off when the plug of the AC adapter is pulled out of the AC inlet.

Charge with the dual battery pack charger

The steps below describe charging the 7500 main battery with the dual battery pack charger (PBT7531-03). The picture below shows the dual battery pack charger with one 7500 main unit battery in correct charging position.



- (1) Connect the AC cable, which accompanies the dual battery pack charger, to the pack charger.
- (2) Verify the voltage levels of the AC cable correspond with the AC outlet. Insert the AC cable in the AC outlet.
- (3) Connect the battery to the battery pack charger. Up to two batteries can be connected simultaneously.
 - Charging will automatically begin.

The LED turns green while the unit is being charged. The LED turns off when charging has completed. Charging time is approximately 2.5 hours.

NOTE

If the LED of the dual battery pack charger flashes red, verify that the battery(s) is connected securely inside the pack charger. If the battery(s) is connected correctly and the LED is still flashing red, than that indicates a problem with the battery or the battery has reached the end of its life cycle. Replace the battery(s) with a new one.

1.3.3 Setting/Removing the battery

Setting the battery

- (1) Two battery lock switches reside on the back surface of the 7500.
Slide the battery lock switches to the [UNLOCK] position.
- (2) Insert the battery correctly into the handheld until a “click” is heard.
- (3) Slide the battery lock switches to the [LOCK] position.
- (4) Reverse these steps to insert a new or fully charged battery into the handheld.

NOTE

The power supply will turn on when the battery lock switches are set to the [LOCK] position.

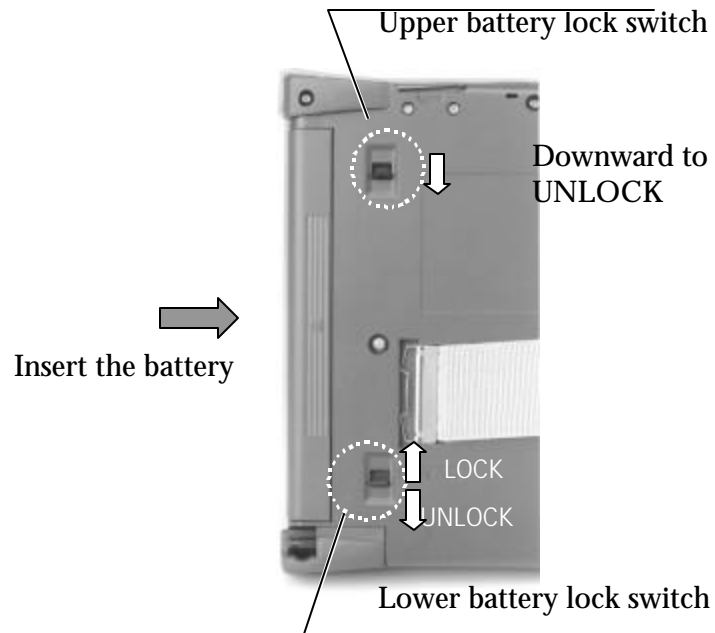

2 TeamPad 7500 Setup

Correct setup of the TeamPad 7500 consists of the following task:

Network Settings

Change network settings and SS radio settings.

Server Settings

Set connect entry to server.

Terminal Server/Power Saving Settings

Set power saving and auto-connect to server settings.

NOTE

Before setup can begin, please charge the battery and insert it into the handheld.
For more information, please refer to:

1.3 Battery Usage

>> Reference>> “3.7 Adjusting the TeamPad 7500 Setup Settings” when it is set up again.

2.1 Setting the Network

- (1) Turn this unit on by pressing the PWR key until LED flashes bright green (about 1 second).
 - This unit will boot up, and the [Change Settings] window for network settings will be displayed.

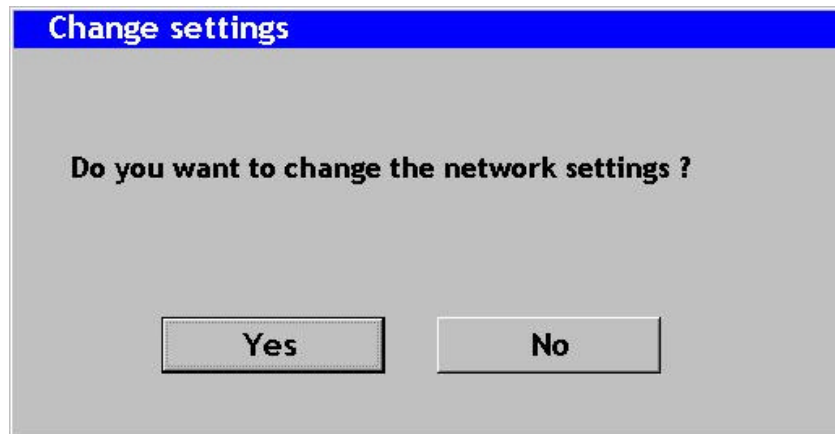

NOTE

This battery might be damaged if the LED flashes green for 5 seconds at an interval of about 0.5 seconds. Replace with a new battery.

There might be a hardware fault if the LED flashes red for 5 seconds at an interval of about 0.5 seconds. Contact a field support service representative.

- (2) Tap on the [Yes] button on the [Change Settings] window for network settings.
 - The screen keyboard and control panel are displayed.
 - >> Reference>> “3.8 Using the Screen Keyboard” for more information on the screen keyboard.

 **Advice** 

Tap on the [No] button to set the terminal server/power saving without changing the network settings when this unit is set up again. By tapping on the [No] button, the screen keyboard and the [Power savings and connecting to Terminal Server] window is displayed.

>> Reference>> “2.2 Setting to connect the Server” about the [Change setting] window for network settings.

- (3) Double-tap on the [Network] icon on the control panel.
 - The [Network] window is displayed.
- (4) Set the items on the [Network] window according to the explanation displayed on the [Network] window.

Tap on the [OK] button after the setting has been terminated.

 - The [Network] window is closed.

NOTE

Ignore the following message displayed, and tap on the [OK] button:

“The new setting becomes valid when the adapter is used the next time. The new setting becomes valid by reinserting the adapter into the device after taking it out of the device if the adapter has been Inserted into the device.”

NOTE

If using a Symbol Spectrum24 card, refer the following action.

If using another vender's RF card, please refer to that specific setup instruction for that vender's RF card.

(5) Double-tap on the [Spectrum24 Settings] icon on the control panel to change the SS radio setting.

➤ The [Spectrum24 Settings] window is displayed.

(6) Set the items on the [Spectrum24 Settings] window.

Tap on the [OK] button after the setting has been terminated.

NOTE

Contact a network system administrator to confirm the settings of items on the [Spectrum24 Settings] window.

➤ The [Spectrum24 Settings] window is closed.

(7) Tap on [Close] from the [File] menu on the control panel.

➤ After the control panel is closed, the [Power savings and connecting to Terminal Server] window is displayed.

2.2 Setting to connect the Server

>> Reference>> “3.8 Using the Screen Keyboard” for more information on about the screen keyboard.

(1) Tap on the [Yes] tab on the [Change settings] window.

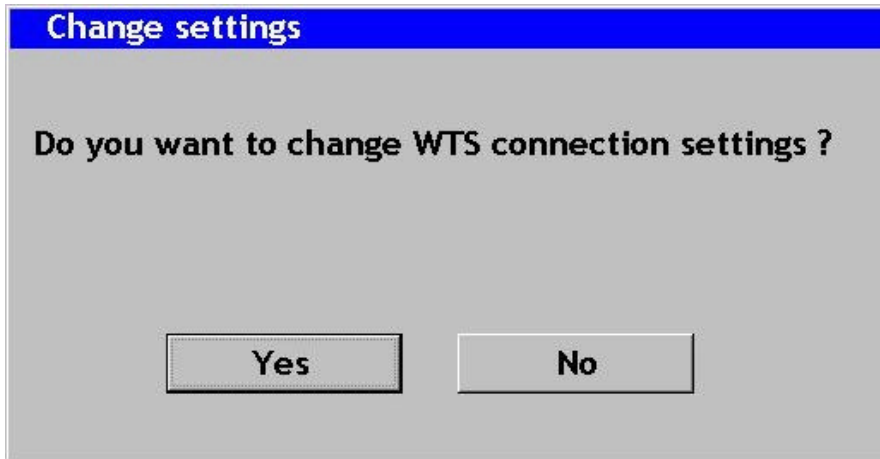

➤ The [WTS Connection Wizard] window is displayed.

📖 Advice 📖

Tap on the [No] tab, don't change WTS connection settings to change settings of this unit. Tap on the [No] tab, display the [Setting the Terminal Server/Power Saving] window.

>> Reference>> “2.3 Enter the Settings for the Terminal Server/Power Saving” to display the “Setting the Terminal Server/Power Saving” window.

(2) Set the following settings with the 1st “WTS Connection Wizard” windows.

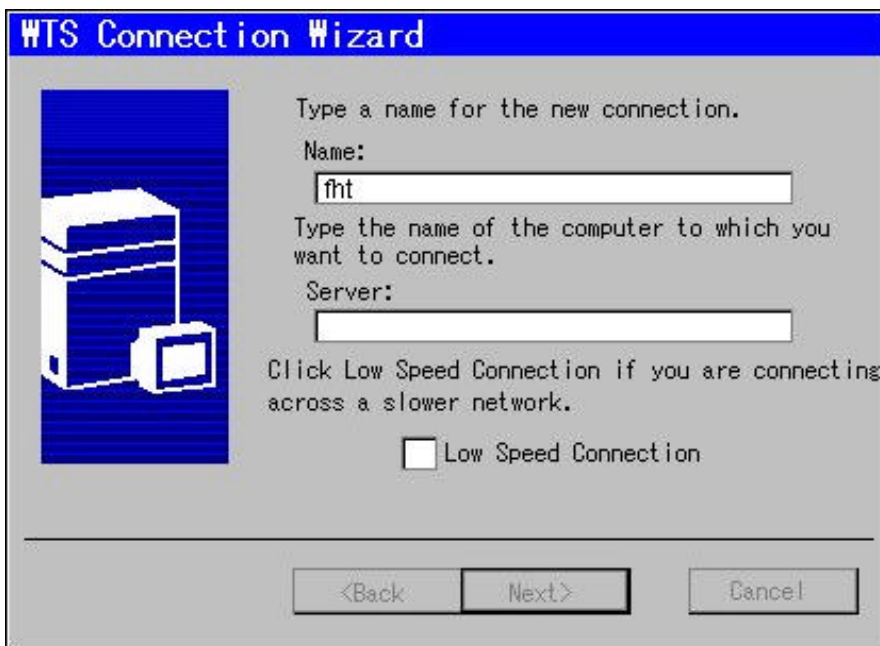

[Name] entry field

Input “fht”. (Fixed)

[Server] entry field

Input the server’s IP address.

[Low Speed Connection] check box

Don’t use “Low Speed Connection”.

Don’t check this check box.

 Advice 

Following items is the tab which mean the “WTS connection wizard” window.

[Back] bottom

Back 1 window to display the “WTS connection wizard” window.

[Next] bottom

Forward 1 window to display the “WTS connection wizard” window.

[Cancel] bottom

Cancel all settings with the “WTS connection wizard” windows, and display the “Setting the Terminal Server/Power Saving” window.

>> Reference >> “2.3 Enter the Settings for the Terminal Server/Power Saving”
to display the “Setting the Terminal Server/Power Saving”
window.

(3) Tap on the [Next] tab.

➤ Display the 2nd [WTS Connection Wizard] window.

-
- (4) Set the following settings on the 2nd [WTS Connection Wizard] window.



- [Automatic Connection To Server] check box

This check box sets whether or not this unit is automatically connected to the server when this unit is turned on.

NOTE

Don't uncheck this checked box, the user name, password, and the domain name must be entered by pressing the Ten key when this unit is connected to the server.

>> Reference >> "3.1.1 Turning on the power supply "

Usually, you can check off [Automatic Connection To Server] this check box.

- [Username] entry field

Enter this field when [Automatic Connection To Server] check box.

Enter the username to connect the server automatically.

- [Password] entry field

Enter this field when [Automatic Connection To Server] check box.

Enter the password to connect the server automatically.

Enter the same password to entry the server in [Password] entry field.

When the [Password] entry field over flow at the server, an error has occurred at the end of [WTS Connection Wizard]. At this time, enter the correct [Password] entry field.

- [Domain] entry field

Enter this field when [Automatic Connection To Server] check box.

Enter the domain to connect the server automatically.

- (5) Tap on the [Next] tab.

- Display the 3rd [WTS Connection Wizard] window.

(6) Set the following settings on the 3rd [WTS Connection Wizard] window.



[Desktop]

Select [Desktop] when an optional application software is not started just after connecting to the server.

[Application File Name]

Select [Application File Name] when an optional application software is started just after connecting to the server. Enter the file name of the application software to be started to the lower entry field, starting with the drive name.

[Work Directory] entry field

The [Work Directory] entry field becomes valid when [Application File Name] is selected in [Program Started When Connecting To Server].

(7) Tap on the [Next] tab.

- Display the 4th [WTS Connection Wizard] window and display the connection entry to set this time. Don't tap on the [Next] tab at the 3rd [WTS Connection Wizard] window, make sure to set the [Application File Name] and [Work Directory].

(8) Tap on the [Finish] tab on the 4th [WTS Connection Wizard] window.



➤ Close the [WTS connection wizard] window, and display the [Setting the Terminal Server/Power Saving] window.

☒ This is the end of operation to set connection the server.

Refer back to “2.3 Enter the Settings for the Terminal Server/Power Saving” for more information on this process.

2.3 Enter the Settings for the Terminal Server/Power Saving

>> Reference >> “3.8 Using the Screen Keyboard” for more information about the screen keyboard

(1) Tap on the [Power saving] tab on the [Power savings and connecting to Terminal Server] window.

(2) Set the following with the [Power savings] tab:

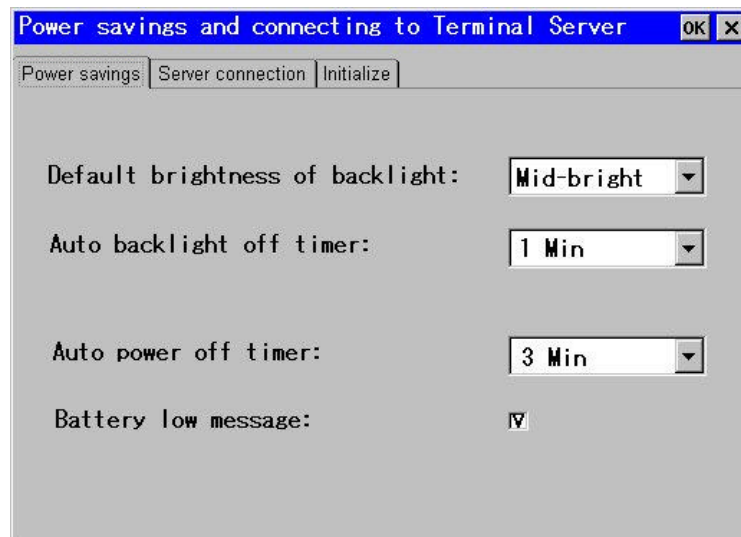

- [Default brightness of back light]
Select the brightness of the back light when the power supply of this unit is turned on, from the list box.
 - [Auto back light off timer]
Select the time between the no-operation time and the automatic set to the darkest setting of this unit from the list box. Select [Inhibit] if the back light is not set to the darkest setting automatically.
 - [Auto power off timer]
Select the time between the no-operation time and the automatic power-off of this unit from the list box. Select [Inhibit] if the power supply of this unit is set to not automatically turn off.
 - [Battery low message]
Click off the check box to display the message when the residual battery capacity has reached a low amount.
- (3) Tap on the [Server connection] tab.
- (4) Set the following with the [Server connection] tab:

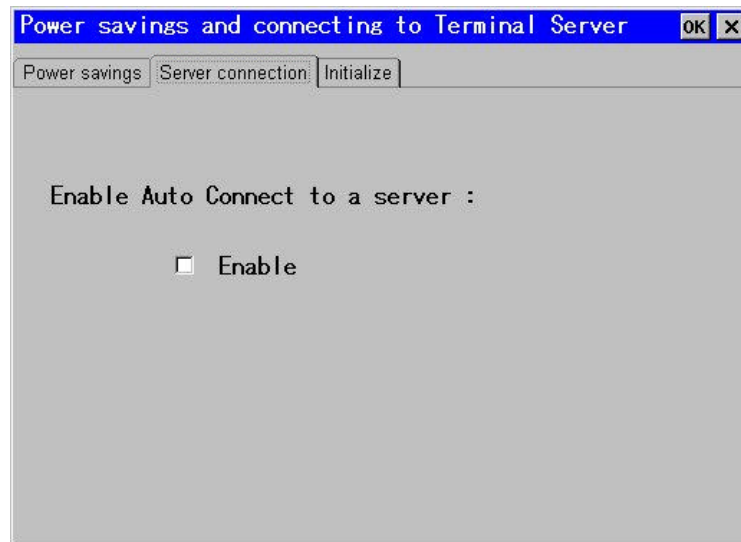

- [Auto Connect to a server]
Click off the [Enable] check box to connect server automatically when terminal is turned on.

Advice

If [Enable] check box is not checked off, the [Terminal Server client] window will be displayed when terminal is turned on. It can control server connection with using [Terminal Server Client] windows. The server name on [Terminal Server client] windows will be set with the value is configured on [Server] entry field of

[WTS wizard] as default.

>> Reference >> Please refer to “3.1.1 Turning on the Power Supply” about [Terminal Server Client]

Please check this check box normally.

(5) Tap on the [OK] button on the [Power savings and connecting to Terminal Server] window.

➤ The [Save Settings] window is displayed.

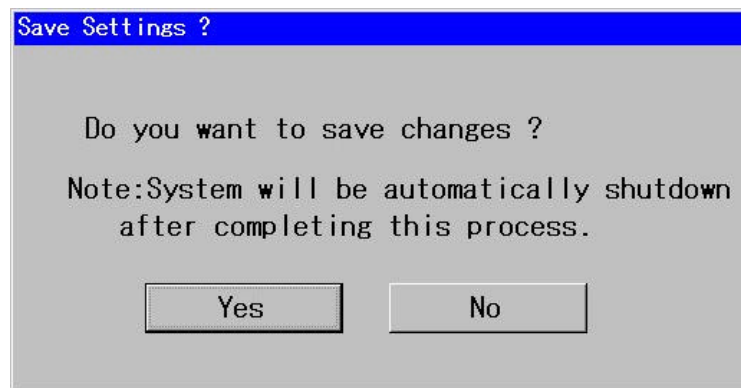

📖 Advice 📖

The [Initialize] tab is used for initializing the setup settings.

>> Reference >> “3.7.2 Initializing the setup settings”

(6) Tap on the [Yes] button on the [Save Settings] window.

Tap on the [No] button to terminate the setup without saving any information that has been set during the setup.

➤ The information set during the setup is not saved, and the power supply of this unit is automatically turned off if the [Yes] button has been tapped.

NOTE

It takes a few seconds for the power supply of this unit to be automatically turned off. The [PWR] key must not be pressed before the unit automatically powers off.

3 Using This Unit

3.1 Turning on/off the Power Supply

3.1.1 Turning on the power supply

(1) Press the PWR key while the power supply is being turned off.

- The power supply is turned on.

The LED is lit in green while the screen is not displayed.

NOTE

- There might be a possible hardware fault if the LED flashes red for 5 seconds at an interval of about 0.5 seconds. Contact a field support service representative.
- The [Change setting] window for network settings is displayed by pressing the [PWR] key when this unit has not set up, or when the setup settings have been initialized. Press the [PWR] key again after performing the setup.
>> Reference>> “2 TeamPad 7500 Setup” about the setup.

Advice

This unit will automatically attempt to connect to the server by turning on the power supply of this unit when the automatic connection to the server is set during the setup.

Enter the IP address of the server in the [Terminal Server Client] window. To display this window press the Ten key when turning on this unit if the automatic connection to the server has not been set during the initial setup.

>> Reference>> “2.3 Enter the Settings for the Terminal Server/Power Saving” about the automatic connection to the server.

3.1.2 Turning off the power supply

(1) Execute any of the following operations:

- Terminate any application software currently running.
- Press and hold the [PWR] key (for about 3 seconds) until the power supply has turned off, if the application software is not starting.

➤ The power supply is turned off.

Perform the operation (2) continuously if the power supply is not turned off after terminating the application software.

(2) Execute any of the following operations if the power supply is not turned off even by executing the operation (1):

- Tap on the [Power Off] button if the [Reconnect To Terminal Server] window is displayed.
- Press and hold the [PWR] key (for about 3 seconds) until the power supply is turned off if the [Reconnect To Terminal Server] window is not displayed.

➤ The power supply is turned off.

3.2 Controlling the Speaker's Volume

The following describes the operation to control the speaker's volume.

NOTE

The volume is automatically set to [High] when this unit has been restarted using the Reset switch, or when the battery has been replaced with a new one. Adjust the speaker's volume if necessary.

- (1) Press the [⊛] key by holding on the [SYS] key while the power supply is being turned on.

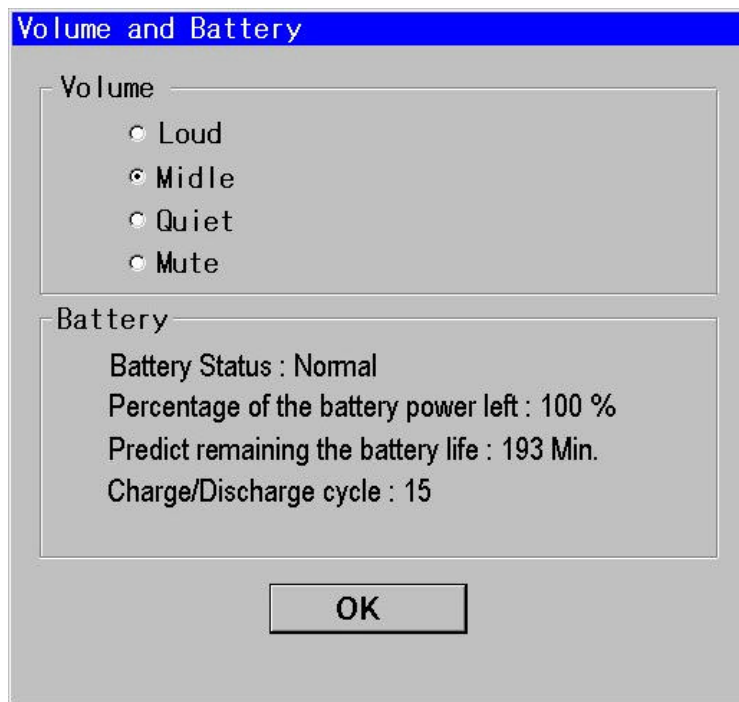

- The [Volume and Battery] window will be displayed.

>> Reference >> “3.3 Confirming the Battery Status” for battery information.

- (2) Select the speaker's volume from [Volume].
- (3) Tap on the [OK] button.

3.3 Confirming the Battery Status

The following describes the operation to confirm the battery status, residual battery capacity, residual expected available time, and charging/discharging count.

- (1) Press the [⌘] key by holding on the [SYS] key while the power supply is being turned on.
 - The [Volume and Battery] window is displayed.

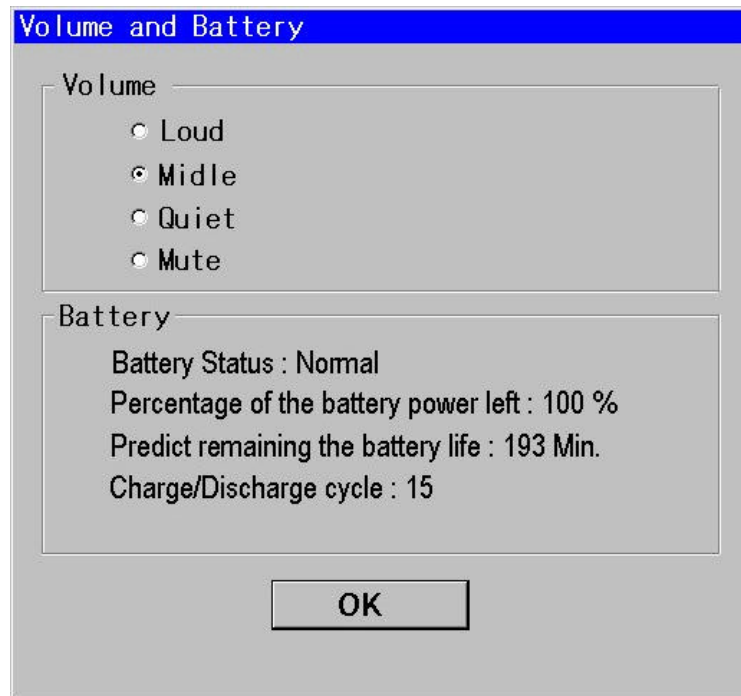

>> Reference >> “3.2 Controlling the Speaker’s Volume” for adjusting the speaker’s volume.

- (2) Confirm the battery status by using [Battery].

The items in [Battery] have the following meanings:

- Status

The battery status is displayed as [Normal], [Insufficient Residual Capacity], [Abnormal], or [Undetermined].

NOTE

- The battery capacity is insufficient if [Insufficient Residual Capacity] is displayed. Charge the battery, or replace it with a spare battery.
- The battery is abnormal if [Abnormal] is displayed. Replace it with a spare battery.
- Please press the [⌘] key by holding on the [SYS] key again. The battery or this

unit is abnormal if [Undetermined] is displayed after few times pressing the [⚙] key by holding on the [SYS]. Please contact field support service.

- Residual battery capacity

The residual battery capacity is displayed with %.

However, [Undetermined] will be displayed in [Residual Battery Capacity] if [Undetermined] is displayed in [Status].

- Residual expected available time

The residual expected available time for the battery is displayed in the unit of minutes.

However, [Undetermined] will be displayed in [Residual Expected Available Time] if [Undetermined] is displayed in [Status].

- Charging/discharging count

The charging/discharging count where the battery was repeated in the past is displayed.

However, [Undetermined] will be displayed in [Number of Charging/Discharging periods] if [Undetermined] is displayed in [Status].

(3) Tap on the [OK] button.

3.4 Controlling the Back Light of the Screen

The following describes the operation to control the back light of the screen.

>> Reference >> “2.2 Setting to connect the Server” about setting the back light brightness when turning on the power supply.

(1) Press the [☼] key while the power supply is being turned on.

- Each time the [☼] key is pressed, the brightness of the back light is changed as follows:

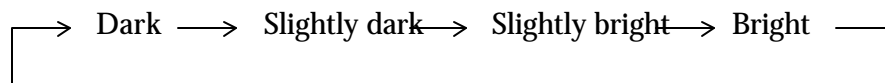

3.5 Controlling the Contrast of the Screen

The following describes the operation to control the contrast of the screen.

(1) Press the [+] key or [-] key while the power supply is being turned on.

- The darkness of the screen is increased each time the [+] key is pressed.
The brightness of the screen is increased each time the [-] key is pressed.

3.6 Calibration of the Touch Panel

The calibration has lost accuracy on the touch panel if the touch panel is not validated by tapping on the screen, or if a different portion of the touch screen is activated than the part which received the input.

In this case, the operation to correct the inaccuracy of the touch panel should be executed. This operation is called “Touch Panel Calibration”. There is no need to perform this calibration when this unit is purchased, because the touch panel has been calibrated.

NOTE

- The [PWR] key must not be pressed while the touch panel calibration tool is running. The touch panel calibration would then need to be re-executed because the setting of touch panel calibration becomes invalid if the [PWR] key is pressed.
- The touch panel calibration must be executed using a fully-charged battery or using the AC adapter connected to the unit. The setup settings are initialized if the battery capacity has become insufficient during the touch panel calibration.
- If battery charge becomes low during the touch panel calibration, replace the battery, then re-execute the touch panel calibration.

(1) Press the [PWR] key by holding on the [SYS] key while the power supply of this unit is being turned off.

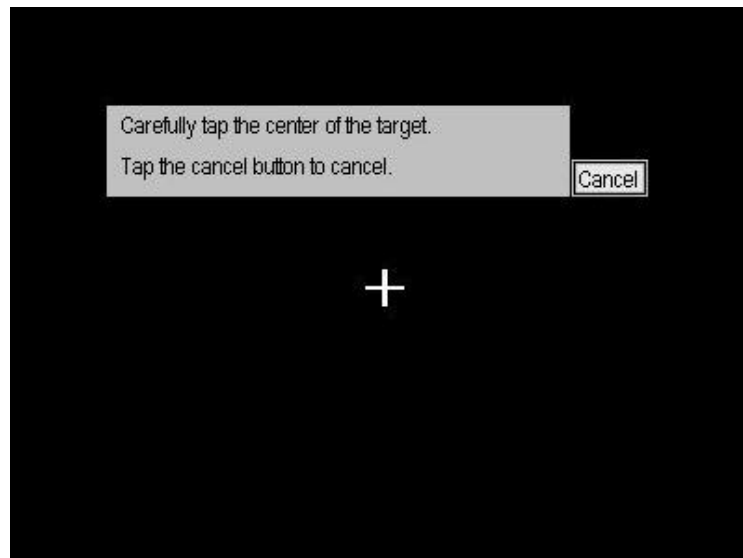

- The touch panel calibration screen is displayed.
- (2) Tap on the [+] mark displayed on the touch panel calibration screen with a stylus.
Tap on the [Cancel] button to stop the touch panel calibration.

NOTE

The tapped [+] does not disappear if the tapped position is about 1 cm distant from the center of [+]. In this case, tap on the [+] mark again.

📖 Advice 📖

The touch panel calibration can be stopped by pressing the [ENT] key if the [Cancel] button is not valid.

- The tapped [+] disappears, and another [+] is displayed at a different position. However, the touch panel calibration will stop, and the unit will restart if the [Cancel] button is tapped.
- (3) Tap on [+] with a pen. Five [+] symbols are sequentially displayed. Tap on these five symbols with a pen in the order indicated on the display.
- The touch panel calibration completion window is displayed by tapping on the fifth [+] symbol.

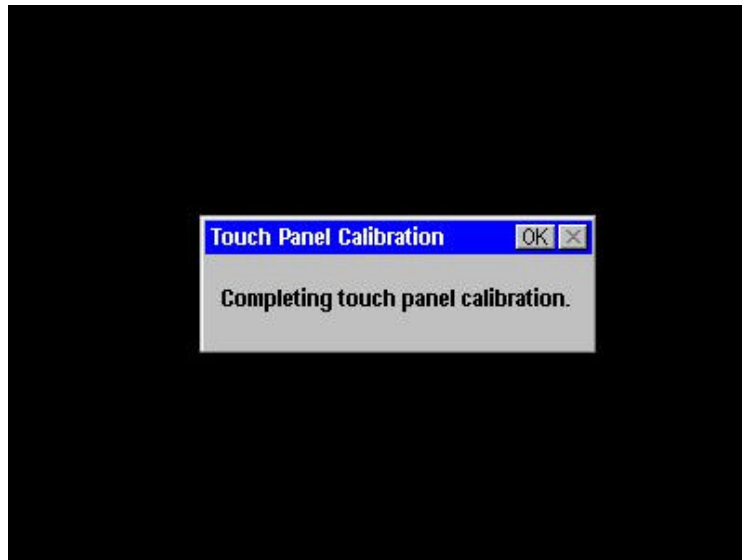



- (4) Tap on the [OK] button on the message window.

📖 Advice 📖

The touch panel calibration can be terminated by pressing the [ENT] key if the [OK] button is invalid.

- This unit is restarted.

 Request 

- The setup settings are initialized if the battery becomes insufficient from when the [OK] button is tapped until this unit is restarted. Perform the setup functions again.
- It takes a few seconds for this unit to be restarted after tapping on the [OK] button. The [PWR] key must not be pressed before this unit is restarted.

3.7 Adjusting the TeamPad 7500 Setup Settings

3.7.1 Changing the setup settings

The following describes the operation to change the setup settings.

- (1) Press the [PWR] key while holding down the [FUNC] key, [SYS] key, and an optional location on the touch panel when the power supply of the unit is being turned off.
 - This unit is started, and the [Change setting] window for network settings is displayed.
- (2) Change the setup settings according to your needs.
 - >> Reference >> From the operation (2) in “2.1 Setting the Network” to “2.3 Enter the Settings for the Terminal Server/Power Saving” about the setup settings.

3.7.2 Initializing the setup settings

The following describes the operation to initialize the setup settings to the mode when this unit is purchased.

Advice

- The [Change setting] window for network settings is displayed by turning on this unit after initializing the setup settings. Set the network.
- The touch panel calibration mode is not initialized even if the setup settings are initialized.

- (1) Press the [PWR] key while holding on the [FUNC] key, [SYS] key, and an optional location on the touch panel when the power supply of this unit is being turned off.
 - This unit is started, and the [Change setting] window for network settings is displayed.
- (2) Tap on the [No] button on the [Change setting] window for network settings.
 - The screen keyboard and [Power savings and connecting to Terminal Server] window is displayed.
- (3) Click on the [Initialize] tab on the [Power savings and connecting to Terminal Server] window.

(4) Click off the [Initialize] check box in the [Initialize] tab.

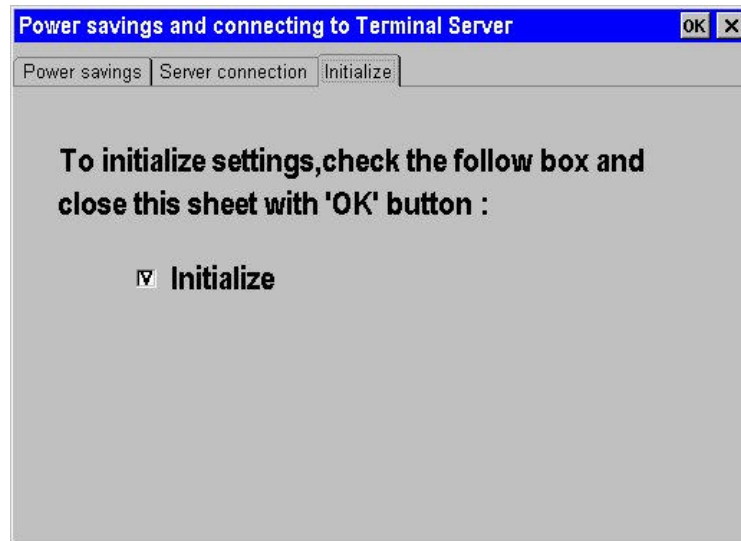

(5) Tap on the [OK] button on the [Power savings and connecting to Terminal Server] window.

➤ The [Save Settings] window is displayed.

(6) Tap on the [Yes] button on the [Save Settings] window.

However, if the setup settings are not initialized, then tap on the [No] button.

➤ The setup settings are initialized, and the power supply of this unit is automatically turned off if the [Yes] button has been tapped.

The setup settings are not initialized, and the power supply of this unit is automatically turned off if the [No] button has been tapped.

3.8 Using the Screen Keyboard

The screen keyboard is a full alphanumeric keyboard which can be accessed by pressing the [SYS] and [DOWN ARROW].

3.8.1 Entering the characters

(1) Tap on a key on the screen keyboard.

- The character is entered.

3.8.2 Changing the mode

The screen keyboard has two modes, i.e., alphabetical lowercase character mode and alphabetical uppercase character mode. The screen keyboard is displayed in alphabetical lowercase character mode.

(1) Tap on the [CAP] key on the screen keyboard while the screen keyboard is being displayed.

- The alphabetical lowercase character mode and alphabetical uppercase character mode are switched alternately each time the [CAP] key is tapped.

4 LED Display

The following explains the action to be taken when the LED is lit or flashes.

4.1 LED Displayed While in Operation

Take action according to the following “Response” if the LED blinks during operation:

LED display		Response
Color	Display status	
Red	Flash (at an interval of about 3 seconds)	<p>The battery voltage is below the specified voltage.</p> <p>Charge the battery, or replace the battery with a spare battery.</p> <p>However, the LED does not blink when this unit is connected to the AC adapter, even if the battery voltage is below the specified voltage.</p>

4.2 LED Displayed When the Power Supply Is On

Take action according to the following “Response” if the LED is lit or flashes when the power supply is turned on:

LED display		Response
Color	Display status	
Green	Fully Lit	This unit has initiated the boot up process. The LED is lit when the [PWR] key is pressed until the screen is displayed.
Red	Blink (for 5 seconds at an interval of about 0.5 seconds)	This unit is abnormal. Contact a Field support service representative.

4.3 LED Displayed While Charging Is Performed

4.3.1 LED of this unit during charging

Take action according to the following “Response” if the LED of this unit is lit or flashes while charging is being performed:

LED display		Response
Color	Display status	
Green	Lit	Charging is being performed. The LED switches off after charging is completed
Green	Flash (at an interval of about 0.5 seconds)	Charging is not performing normally. The battery voltage is below the normal voltage range, or the battery voltage has not reached the specified voltage even after charging has completed. Replace the battery with a new one. The LED switches off by pulling the plug of the AC adapter out of the plug socket.
Red	Lit	The AC adapter voltage is below the specified voltage , so charging cannot be performed. The AC adapter may have a problem, therefore contact a field support service. The LED switches off by pulling the plug of the AC adapter out of the plug socket.

4.3.2 LED of the dual battery pack charger during charging

Take action according to the following “Response” if the LED of the dual battery pack charger is lit or flashes while charging is being performed:

LED display		Response
Color	Display status	
Orange	Lit	During charging.
Green	Lit	Charging is completed.
Red	Blink	Charging cannot be performed since the battery may not be connected correctly to the battery pack charger or the battery may be damaged. Correctly connect the battery to the battery pack charger, or replace the battery with a new one.

5 SS Radio

This unit is used together with the F7511L31 radio LAN base station for communication with a server.

The radio system of this unit adopts the spectrum diffusion system by using the spread spectrum 2.4 GHz band. The user can use this unit without obtaining the radio communication license.

The communicable range is within a 7 m to 35 m radius from the base station as a center under the environment of a shop.

(The communicable range depends greatly on the environment. The communicable range is up to 70 m or so for the open space.)

CAUTION

- This unit must not be used near machinery which may cause electric noises such as microwave oven and security gate.
- This unit should be used distant from TV, radio, and other radio sets.

6 If A Message Is Displayed...

Take action according to the “Response” if any of the following messages are displayed.

Message	Response
The DHCP could not obtain the IP address. Reinsert the card, or allocate the address manually.	The DHCP could not obtain the IP address. Verify whether or not the network has been set for the DHCP to obtain the IP address. Contact the network administrator if the problem persists.
An error has occurred, therefore stop the touch panel calibration.	An error has occurred during the touch panel calibration. Tap on the [OK] button to stop the touch panel calibration, then re-execute the touch panel calibration. >> Reference>> “3.6 Calibration of the Touch Panel” if an error occurs frequently, contact a Field support service representative.
The server could not be connected.	The connection to the server has failed. Verify the setup settings. >> Reference>> “3.7 Adjusting the TeamPad 7500 Setup Settings”
Charge the battery.	The residual battery capacity has become insufficient. Charge the battery, or replace the battery with a new one. >> Reference>> “1.3 Battery Usage”
An error has been detected in the flash ROM.	The set data stored in the flash ROM has been damaged. Set up this unit again. >> Reference>> “3.7 Adjusting the TeamPad 7500 Setup Settings” Contact a Field support service representative if an error occurs frequently.
No data can be saved in the flash ROM.	No data can be written to the flash ROM. Contact a Field support service.
The flash ROM clearing has failed.	The flash ROM cannot be cleared. Contact a Field support service.

Message	Response
The radio LAN driver has not been installed.	The radio LAN driver has not been installed or has been damaged. Contact a Field support service representative.
Terminal Server Client Disconnected.	The message may have exceeded the radio communication range. Send the message again within the radio communication range. >> Reference>> “5 SS Radio”

7 Troubleshooting

Take action according to “Response” before contacting a Field support service representative if any of the following symptoms has been detected during using this unit.

Symptom	Response
The power supply cannot be turned on.	The battery charge may be low. Replace the low capacity battery with a fully charged one. >> Reference>> “1.3 Battery Usage”
	The battery may have reached the end of its lifecycle. Replace the insufficient battery with a new one. >> Reference>> “1.3 Battery Usage”
	Make sure the battery has been correctly installed. For example, the battery lock switch might be set to the [UNLOCK] setting. >> Reference>> “1.3.3 Setting/Removing the
The screen has either been significantly darkened or brightened, therefore it is hard to see.	Control the contrast of the screen. >> Reference>> “3.5 Controlling the Contrast of the Screen”
	The battery charge may be low. Replace the low capacity battery with a charged one. >> Reference>> “1.3 Battery Usage”
The screen is displayed briefly and disappears when the power supply is turned on by pressing the [PWR] key.	The battery charge may be low. Replace the battery with a charged one. >> Reference>> “1.3 Battery Usage”
No sound is coming from the speaker.	The speaker’s volume may be set to [SILENCE]. Verify the speaker’s volume. >> Reference>> “3.2 Controlling the Speaker’s
The touch panel is not valid.	The coordinates on the touch panel may have shifted. Execute the touch panel calibration. >> Reference>> “3.6 Calibration of the Touch Panel”
Terminal Server Client Disconnected.	The message may have exceeded the radio communication range. Send the message again within the radio communication range. >> Reference>> “5 SS Radio”

A TeamPad 7500 Specifications

Item		Specifications
Controller	CPU	64-bit RISC CPU -- 85MHz
	Memory	ROM: 16 MB + 2 MB (Flash ROM) RAM: 16 MB
Display	Type	LCD
	Screen size	800 (width) × 600 (length), SVGA, 256 colors
	Display lighting	High-brightness back light with the FL tube
Operation panel		Touch panel, Back Light key, Contrast key, Contrast key (× 2), Function key, System key, Power key, Reset switch, Ten key, Enter key, Cursor key, Clear key, Decimal Point key, Backspace key.
Audio		Speaker output (Speaker x 1 built-in)
Radio		2.4 GHz, spread spectrum, radio LAN, based on 802.11, 2 Mbps.
Power supply	Battery	Li ion battery pack, 1750 mAh
	Operational time	Approx. 3 hours
	Charging period	About 2.5 hours
Environmental conditions	Temperature	Operation: 32°F to 104°F (0°C to 40°C) Storage: -4°F to 140°F (-20°C to 60°C)
	Humidity	Operating: 20% to 85% Storage: 20% to 85%
Dimensions		10.0" W x 1.0" H x 7.0" D (255 × 25 × 178 mm)
Weight		1.9 lbs. 860g (including the battery's weight)

B Expendable Supplies

The following describes the expendable supplies which the user needs when making replacements in this unit.

Product name	Product number	Life
1750 mAh Battery Pack	PBT7531-05	About 500 charging and discharging times (The charging and discharging count may be less than 500, depending on the operational conditions.)

Other parts except the above may need to be replaced at the user's cost if they are used beyond the Fujitsu-defined limits of use.

Contact a Field support service representative for details of the Fujitsu-defined limits of use as well as the parts that may be replaced.

C Accessories

Accessory	Remarks
Battery pack	1 ea. PBT7531-05
Pen Stylus	1 ea. PBT7633-05
Hand strap	1 ea. PBT7633-01
Instruction Manual	1 ea. PBT90000079

- * The pen and hand strap can be purchased individually by specifying the above Model numbers.)

D Optional Equipment

Product name	Model number	Specification
Dual Battery Pack Charger	PBT7531-03	Unit for charging one or two batteries. The charging period is about 2.5 hours.
Neck strap	FHTNS701	Strap used for suspending this unit from the neck of the user

Index

A

Accessories45

B

Battery

charging7

details6

removing.....14

setting14

status, confirming28

usage.....6

C

Calibration of the touch panel.....31

Changing mode.....35

Charging with AC adapter.....11

Charging with battery pack charger12

Charging with charging stand8

Component names.....2

Controlling back light.....30

Controlling contrast30

Controlling speaker's volume27

E

Entering characters.....36

Expendable supplies44

L

LED36

displayed while in operation36

displayed while power supply is on.....37

of battery pack charger during charging.....38

of this unit during charging.....37

M		
	Message.....	40
O		
	Optional equipment.....	46
P		
	Power supply	
	turning off.....	25
	turning on	25
S		
	Setting network	18
	Setting terminal server/power saving.....	22
	Setup	
	changing settings.....	34
	initializing settings.....	34
	operation to be performed first.....	17
	Specifications.....	43
	SS radio	39
T		
	TeamPad (FHT601)	
	before using.....	1
	overview of	1
	using	25
	Troubleshooting	42
U		
	Using screen keyboard.....	36